

Serial Communication Programmer Reference Guide

Powermax45/65/85/105 SYNC[®]

Reference Guide

Hypertherm, Inc.

21 Great Hollow Road, P.O. Box 5010
Hanover, NH 03755 USA
603-643-3441 Tel (Main Office)
603-643-5352 Fax (All Departments)
info@hypertherm.com (Main Office)

800-643-9878 Tel (Technical Service)

technical.service@hypertherm.com (Technical Service)

800-737-2978 Tel (Customer Service)

customer.service@hypertherm.com (Customer Service)

Hypertherm México, S.A. de C.V.

52 55 5681 8109 Tel
52 55 5681 7978 Tel
soporte.tecnico@hypertherm.com (Technical Service)

Hypertherm Plasmatechnik GmbH

Sophie-Scholl-Platz 5
63452 Hanau
Germany
00 800 33 24 97 37 Tel
00 800 49 73 73 29 Fax

31 (0) 165 596900 Tel (Technical Service)**00 800 4973 7843 Tel (Technical Service)**

technicalservice.emeia@hypertherm.com (Technical Service)

Hypertherm (Singapore) Pte Ltd.

Solaris @ Kallang 164
164 Kallang Way #03-13
Singapore 349248, Republic of Singapore
65 6841 2489 Tel
65 6841 2490 Fax
marketing.asia@hypertherm.com (Marketing)
techsupportapac@hypertherm.com (Technical Service)

Hypertherm Japan Ltd.

Level 9, Edobori Center Building
2-1-1 Edobori, Nishi-ku
Osaka 550-0002 Japan
81 6 6225 1183 Tel
81 6 6225 1184 Fax
htjapan.info@hypertherm.com (Main Office)
techsupportapac@hypertherm.com (Technical Service)

Hypertherm Europe B.V.

Laan van Kopenhagen 100
3317 DM Dordrecht
Nederland
31 165 596907 Tel
31 165 596901 Fax
31 165 596908 Tel (Marketing)
31 (0) 165 596900 Tel (Technical Service)
00 800 4973 7843 Tel (Technical Service)
technicalservice.emeia@hypertherm.com (Technical Service)

Hypertherm (Shanghai) Trading Co., Ltd.

B301, 495 ShangZhong Road
Shanghai, 200231
PR China
86-21-80231122 Tel
86-21-80231120 Fax
86-21-80231128 Tel (Technical Service)
techsupport.china@hypertherm.com (Technical Service)

South America & Central America: Hypertherm Brasil Ltda.

Rua Bras Cubas, 231 – Jardim Maia
Guarulhos, SP – Brasil
CEP 07115-030
55 11 2409 2636 Tel
tecnico.sa@hypertherm.com (Technical Service)

Hypertherm Korea Branch

#3904. APEC-ro 17. Heaundae-gu. Busan.
Korea 48060
82 (0)51 747 0358 Tel
82 (0)51 701 0358 Fax
marketing.korea@hypertherm.com (Marketing)
techsupportapac@hypertherm.com (Technical Service)

Hypertherm Pty Limited

GPO Box 4836
Sydney NSW 2001, Australia
61 7 3103 1695 Tel
61 7 3219 9010 Fax
au.sales@hypertherm.com (Main Office)
techsupportapac@hypertherm.com (Technical Service)

Hypertherm (India) Thermal Cutting Pvt. Ltd

A-18 / B-1 Extension,
Mohan Co-Operative Industrial Estate,
Mathura Road, New Delhi 110044, India
91-11-40521201/ 2/ 3 Tel
91-11 40521204 Fax
htindia.info@hypertherm.com (Main Office)
technicalservice.emeia@hypertherm.com (Technical Service)

Powermax, SYNC, SmartSYNC, and Hypertherm are trademarks of Hypertherm, Inc. and may be registered in the United States and other countries. All other trademarks are the property of their respective holders.

Environmental stewardship is one of Hypertherm's core values, and it is critical to our success and our customers' success. We are striving to reduce the environmental impact of everything we do. For more information: www.hypertherm.com/environment.

© 2021 – 2024 Hypertherm, Inc.

Contents

Getting started.....	7
Hardware requirements	7
Powermax SYNC hardware documents	8
Modbus specifications.....	8
Transmission mode and format	8
Modbus request and response message frame format.....	10
Error response message frame format.....	11
Example request and response message.....	11
How to calculate a checksum (LRC).....	13
CNC settings on the Powermax65/85/105 SYNC	13
CNC settings on the Powermax45 SYNC.....	15
Powermax SYNC Modbus addressing system	17
Backward compatible with 0x2xxx series.....	17
List of Powermax SYNC addresses.....	18
Programming recommendations.....	21
Examples of requests and responses	22
Identify the plasma power supply type (SYNC or older system)	22
Example request and response.....	22
Read the ID of the SYNC torch, torch lead, and plasma power supply.....	23
0x3000 (torch and plasma power supply identification).....	23
Example request and response.....	24
Read the part number of the installed cartridge	25
0x3038, 0x3039, 0x303A (cartridge part number, bytes 0 – 5).....	25
Example request and response.....	27

Read the plasma power supply settings that are permitted for the installed cartridge	28
0x3001 (permitted operating mode setting).....	28
0x3002, 0x3003 (permitted minimum and maximum output current (A) settings).....	28
0x3004, 0x3005 (permitted minimum and maximum gas pressure settings).....	28
Example request and response.....	29
Write operating settings and put the plasma power supply into remote control mode.....	30
0x3080 (operating mode setting)	30
0x3081 (output current (A) setting).....	30
0x3082 (gas pressure setting)	31
Example request and response.....	31
Remote control mode indicator on the plasma power supply	32
Do a check for an active fault	33
0x301A (active fault code).....	33
Example request and response.....	33
Fault code list.....	34
Start and stop a gas test.....	37
0x3180 (coil: gas test).....	37
Example request and response.....	38
Stop fault code 0-50-0.....	39
0x308E, 0x308F (stop fault code 0-50-0 with a quick restart).....	39
Example request and response.....	40
Exit remote control mode	41
Example request and response.....	41
Get data from the plasma power supply	42
Read the plasma power supply settings.....	42
0x3010 (operating mode).....	42
0x3011 (output current (A) setting).....	42
0x3012 (gas pressure setting).....	43
Example request and response.....	43
Read the actual output of the plasma power supply	44
0x3018 (actual output current).....	44
0x3019 (actual gas pressure).....	44
Example request and response.....	44

Read the total cut counts for this plasma power supply.....	45
0x3028 (total number of torch starts – bytes 1 and 0).....	45
0x3029 (total number of starts – bytes 3 and 2).....	46
0x302A (cumulative pilot arc time – bytes 1 and 0).....	46
0x302B (cumulative pilot arc time – bytes 3 and 2).....	46
0x302C (total number of arc transfers – bytes 1 and 0).....	46
0x302D (total number of arc transfers – bytes 3 and 2).....	47
0x302E (cumulative arc transfer time – bytes 1 and 0).....	47
0x302F (cumulative arc transfer time – bytes 3 and 2).....	47
Example request and response.....	48
Read the 16-character UID number for the installed cartridge	49
0x3030 – 0x3037 (cartridge UID, bytes 0 – 15).....	49
Example request and response.....	50
Read the total cut counts for the installed cartridge.....	51
0x3040 (total number of starts).....	51
0x3041 (cumulative pilot arc time).....	51
0x3042 (total number of arc transfers).....	51
0x3043 (cumulative arc transfer time)	52
Example request and response.....	52
Read the 4 most recent faults for the installed cartridge.....	53
0x3044 (fault log 0).....	53
0x3045 (fault log 1).....	54
0x3046 (fault log 2).....	54
0x3047 (fault log 3).....	54
Example request and response.....	55
Read the name of the installed cartridge.....	56
0x3048 – 0x304D (cartridge name, bytes 0 – 11)	56
Example request and response.....	57
Read the Start and Motion signal status of the plasma power supply	58
0x3100 (coil: Start switch signal status)	58
0x3101 (coil: Motion switch signal status).....	58
Example request and response.....	59

Flowchart Examples 61

Getting started

The Powermax SYNC plasma power supply supports serial communication with an external control using the Modbus serial communication protocol.

This guide helps programmers use Modbus protocols and messages to connect the Powermax SYNC with external controls, like a CNC or torch height control (THC). It shows which Modbus function codes and Powermax SYNC register and coil addresses to use. It also explains how to make messages for the Powermax SYNC.

For more information about the Modbus protocol, refer to modbus.org.

Hardware requirements

Using a Powermax SYNC plasma power supply in a mechanized system requires all of the following hardware.

- **SmartSYNC machine torch with torch lead and Hypertherm cartridges.**
- **RS-485 serial interface connector, board, and cables.** This hardware provides access to cut mode, amperage, gas pressure, and more.
- **Machine interface receptacle, voltage divider board, and cables.** This hardware provides access to the divided arc voltage, plasma start/stop, and arc transfer signals.

If this hardware was not included with your system, you must order and install the hardware. Refer to the *Powermax45/65/85/105 SYNC Parts Guide* (810490).

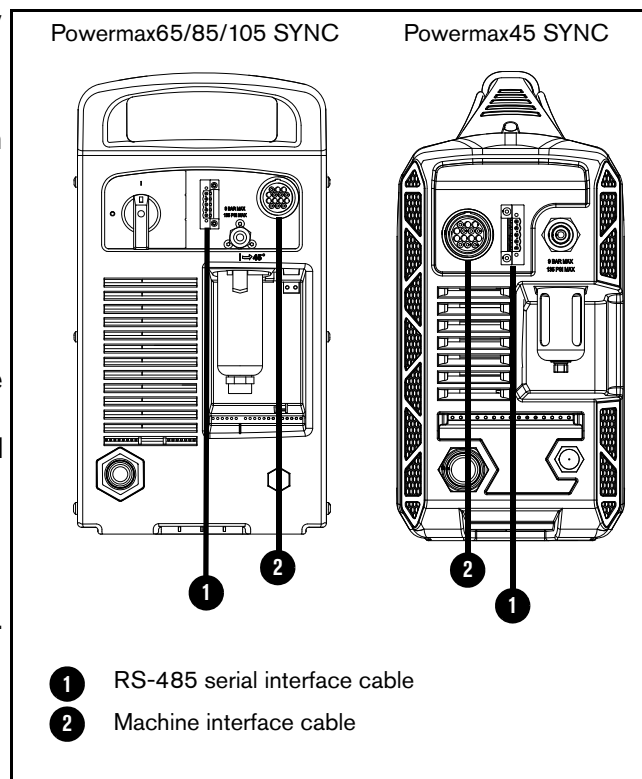

Powermax SYNC hardware documents

Refer to the following documents for more information about the required hardware for serial communications.

How-to Information	Document
Order hardware, kits, and cables	<i>Powermax45/65/85/105 SYNC Parts Guide (810490)</i>
Attach a machine torch to a cutting table	<i>Powermax45/65/85/105 SYNC Mechanized Cutting Guide (810480)</i>
Install an RS-485 serial interface connector and board	<i>RS-485 Serial Interface Connector with PCB Field Service Bulletin (806710) - Powermax65/85/105 SYNC</i> <i>RS-485 Serial Interface Connector with PCB Field Service Bulletin (809930) - Powermax45 SYNC</i>
Install a machine interface receptacle and voltage divider board	<i>Machine Interface Receptacle with Voltage Divider PCB Field Service Bulletin (806980) - Powermax65/85/105 SYNC</i> <i>Machine Interface Receptacle with Voltage Divider PCB Field Service Bulletin (809940) - Powermax45 SYNC</i>
Connect external serial interface and machine interface cables	<i>Powermax45/65/85/105 SYNC Mechanized Cutting Guide (810480)</i>

You can find these documents on the USB memory stick that came with your plasma power supply (Powermax65/85/105) or by scanning the QR code on the side of the plasma power supply.

Technical documentation is also available at www.hypertherm.com/docs.

Modbus specifications

Transmission mode and format

Mode	ASCII (American Standard Code for Information Interchange)
Addressing	Controller: CNC Connected device: <i>Powermax45/65/85/105 SYNC</i>
Coding system	Hexadecimal, ASCII characters 0 - 9, A - F
Baud rate	19200
Bits per byte	Start bit: 1 Data bits: 8 <ul style="list-style-type: none"> ▪ Includes 1 bit for even parity ▪ Most significant byte (MSB) sent first Stop bit: 1*

Parity	Even**
Error-check field	Longitudinal Redundancy Check (LRC)
<p>* The stop bit setting on the plasma power supply and the external control must be the same. By default the Powermax SYNC plasma power supplies are set to 1 stop bit. Refer to <i>CNC settings on the Powermax65/85/105 SYNC</i> on page 13 or <i>CNC settings on the Powermax45 SYNC</i> on page 15.</p> <p>** The parity setting on the plasma power supply and the external control must be the same. By default the Powermax SYNC plasma power supplies are set to Even parity. Refer to <i>CNC settings on the Powermax65/85/105 SYNC</i> on page 13 or <i>CNC settings on the Powermax45 SYNC</i> on page 15.</p>	

Modbus request and response message frame format

Start	Node Address	Function	Data	LRC	End
1 character :	2 characters	2 characters	0 up to 2x252 characters	2 characters	2 characters <CR><LF>

Each segment is explained as follows.

Segment	Description
Start	All messages must start with a colon (:). This character identifies that a new message follows.
Node Address	<p>In a request message: These characters identify the unique address (node address) of the plasma power supply to which the request message is being sent.</p> <p>In a response message: These characters identify its node address to confirm that the correct plasma power supply responded.</p>
Function	<p>In a request message: The function code tells the plasma power supply what to do. If needed, the Data characters provide additional information about how to do the function.</p> <p>In a response message: The function code confirms the function that was done by the plasma power supply.</p> <p>In an error response message: The Function segment of the message is different. Refer to page 11.</p>
Data	<p>In a request message: These characters can be included to provide additional information about how to do the function. This can include items like discrete and register addresses, the quantity of items to be handled, and the count of actual data bytes in the field.</p> <p>In a response message: These characters represent the result of the function done by the plasma power supply.</p> <p>In an error response message: The Data segment of the message is different. Refer to page 11.</p>
LRC	<p>These characters are used to perform a Longitudinal Redundancy Check (LRC), a method for performing a checksum on the message.</p> <p>In a request message: The LRC value is calculated by the CNC. When the plasma power supply receives the request message, it also calculates an LRC for the request message. If the LRCs are the same, the plasma power supply accepts the request message.</p> <p>For more information on how to calculate an LRC, refer to page 13.</p> <p>In a response message: The LRC value is calculated by the plasma power supply for the data in its response message. The CNC performs a checksum before accepting the response message.</p>
<CR><LF>	These characters identify the end of the message.

Error response message frame format

The plasma power supply sends an error response message to the CNC when it detects an error in the request data and when an error occurs during processing of the request.

The format of the error response message is similar to the request and response message format, with the following differences.

Segment	Description
Function	In an error response message: The MSB of the function code is set to 1. This makes the function code value 80 hexadecimals higher than the value would be for a normal response. This identifies to the CNC that this is an error response message. For example, if the request message contained the Read Register function code of 04, the error response message would contain 84 in the Function segment of the message.
Data	In an error response message: The Data segment of the message contains an exception code that identifies the reason for the error. For example, if the function code in the request message is invalid for the plasma power supply, the Data segment of the error response message contains the 01 exception code (Illegal Function).

Example request and response message

The following is a request for the 4 most recent faults for the installed cartridge:

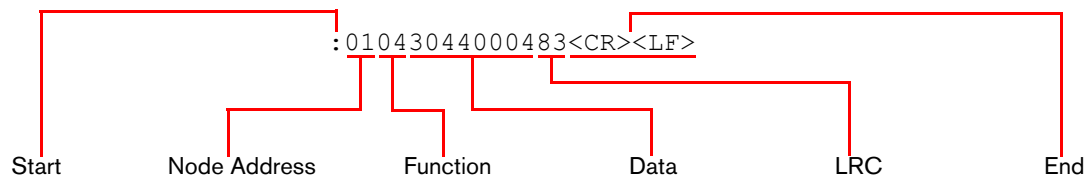

Segment	Value	Description
Start	:	Start of message
Node Address	01	Plasma power supply node address
Function	04	Read Registers
Data	3044	First register address (0x3044)
	0004	Quantity of registers to read (0x0004 = 4): <ul style="list-style-type: none"> ▪ 0x3044 (fault log 0) ▪ 0x3045 (fault log 1) ▪ 0x3046 (fault log 2) ▪ 0x3047 (fault log 3)
LRC	83	Checksum
End	<CR><LF>	End of message

The following is the response from the plasma power supply:

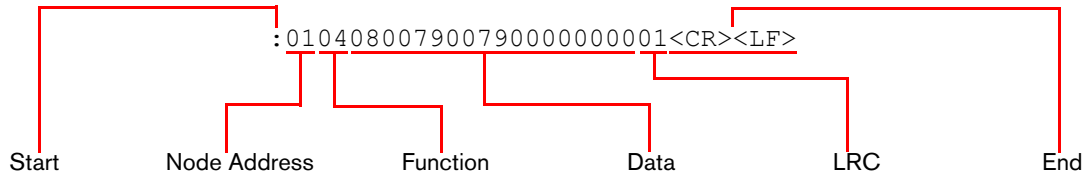

Segment	Value	Description
Start	:	Start of message
Node Address	01	Plasma power supply node address (confirmed)
Function	04	Read Registers (confirmed)
Data	08	Quantity of bytes in the Data segment (0x08 = 8)
	0079	Value in address 0x3044 (newest fault): 0x0079 = 0121 = fault code 0-12-1 (output gas pressure is low)
	0079	Value in address 0x3045: 0x0079 = 0121 = fault code 0-12-1 (output gas pressure is low)
	0000	Value in address 0x3046: 0x0000 = 0000 = 0-00-0 (no fault code)
	0000	Value in address 0x3047 (oldest fault): 0x0000 = 0000 = 0-00-0 (no fault code)
LRC	01	Checksum
End	<CR><LF>	End of message

For more examples, refer to *Examples of requests and responses* on page 22.

How to calculate a checksum (LRC)

Modbus ASCII requires a longitudinal redundancy check (LRC, also called a checksum) on each message.

For example, in the following request message, the LRC is 83.

:01043044000483<CR><LF>

Start	Node Address	Function	Data		LRC	End
:	01	04	3044	0004	83	<CR><LF>

1. Add the hexadecimal values of the message, excluding the Start (:) and End characters (<CR><LF>) and the LRC itself (83):

For example: $0x01 + 0x04 + 0x30 + 0x44 + 0x00 + 0x04 = 0x7D$

2. Do one of the following:

- a. If the sum is less than or equal to FF, subtract the entire value from FF.
- b. If the sum is more than FF, subtract the last two digits from FF.



In this example, 0x7D is less than FF, so you subtract the entire value from FF:

$0xFF - 0x7D = 0x82$

3. Add 1. For example: $0x82 + 0x01 = 0x83$. The LRC is 83.

CNC settings on the Powermax65/85/105 SYNC

Use the CNC Interface Settings screen (**CNC INTERFACE**) to set parameters for serial communication.

1. Select ⁴ on the main menu screen.
2. Select ² to go to the **CNC INTERFACE** screen.
3. Turn the adjustment knob to go to the field you want to change.
4. Push  to select the field.
5. Turn the adjustment knob to change the value in the field.

6. Push \square/\rightarrow to select the new value.

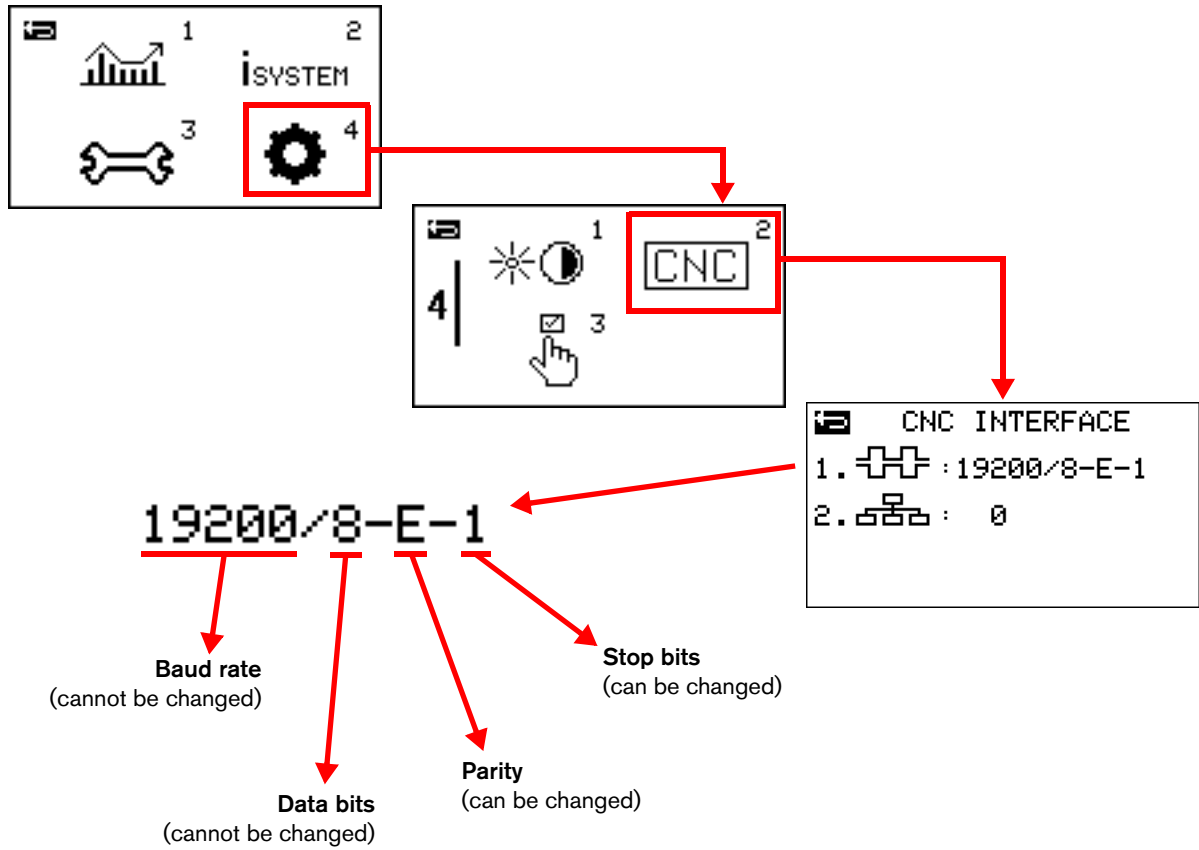

 – Set the parity-check configuration and stop-bit configuration for this Powermax. Make sure that the values in this field are the same as the values at the CNC.

Select one of the following values for **parity checking**:

E	Even (default)
O	Odd
N	No parity checking

Select one of the following values for **stop bit**:

1	1 stop bit (default)
2	2 stop bits

 – This is the Modbus node address for this Powermax. The default value is zero (0).

- ❑ **For cutting systems with 1 Powermax plasma power supply:** Keep the default value of zero (0).

A value of zero (0) lets the CNC set the node address for the Powermax automatically. The node address is set by the first valid Modbus request message that the Powermax receives from the CNC after the Powermax power switch is set to the ON (I) position. This field continues to show a value of zero (0) during Modbus communication to indicate that the node address is being controlled by the CNC.

- ❑ **For cutting systems with 2 or more Powermax plasma power supplies:** Select a unique number from 1 to 255 for each Powermax.
 - After you set the node address for this Powermax, do a cold restart.
 - Make sure that the CNC uses this node address when it communicates with each Powermax.

CNC settings on the Powermax45 SYNC

Use the Powermax45 SYNC configuration menu to set parameters for serial communication.

1. Push and hold the mode button ① until S.U. shows on the screen ②.

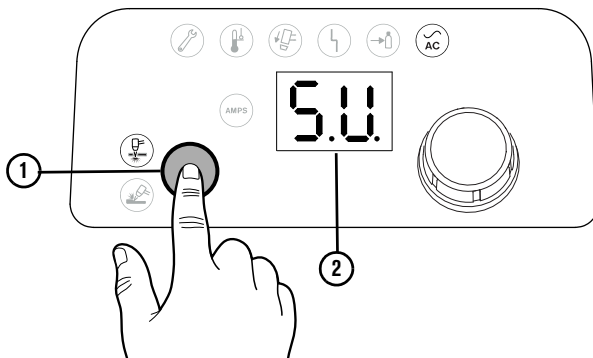

2. Release the mode button.

3. Turn the control knob ③ to go to the field you want to change ④.
4. Push the mode button ⑤ to select the field.
5. Turn the control knob to change the value in the field ⑥.
6. Push the mode button ⑦ to select the new value.

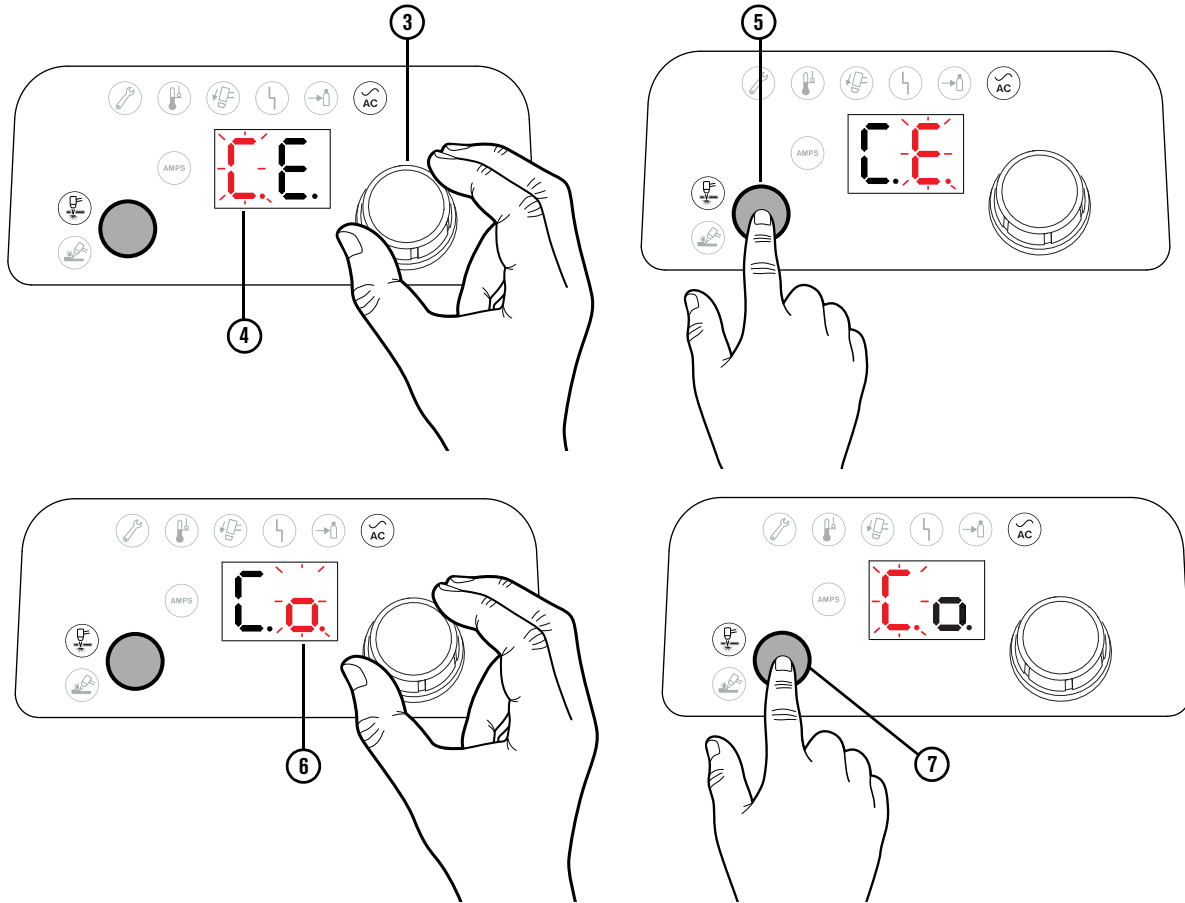

7. Repeat steps 3 through 6 to change the following node address settings as necessary.

Field	Description	Settings
	CNC parity bit	E = even parity (default) o = odd parity n = no parity check
	CNC stop bit	1 = send stop bit (default) 2 = no stop bit
	CNC node address. Default = 000.	 CNC node address set to 245.

8. Select then press the mode to exit the setup menu and save your changes.

9. Do a cold restart of the plasma power supply.

Powermax SYNC Modbus addressing system

Powermax SYNC provides more plasma power supply data than what is available for older Powermax plasma power supplies, as well as access to cartridge-usage data. A CNC can also request a gas test and a quick restart on a Powermax SYNC.

The Powermax SYNC register addresses are consecutively numbered in a 0x3xxx series of registers so that a single request can read or write multiple related registers at one time.

For the most efficient communication between a CNC and a Powermax SYNC, do the following:

- Use only the 0x3xxx register addresses with Powermax SYNC.
- When possible, send a single request for multiple registers of data at one time.

Backward compatible with 0x2xxx series

Powermax SYNC supports the 0x2xxx series of Modbus addresses that was used for older Powermax plasma power supplies, as shown in *Table 1*. **But Hypertherm strongly recommends that you use the 0x3xxx series with the Powermax SYNC.**

Older Powermax plasma power supplies include Powermax65/85/105/125 and Powermax45 XP.

Table 1 – Powermax SYNC support for old addressing system

Old address	Description	Modbus functions (hex)
0x204C	Actual gas pressure	04 (Read Register)
0x2093	Operating mode setting	06 (Write Single Register)
0x2094	Output current (A) setting	06 (Write Single Register)
0x2096	Gas pressure setting	06 (Write Single Register)
0x2098	Active fault code	04 (Read Register)
0x2099	Minimum output current (A) setting	04 (Read Register)
0x209A	Maximum output current (A) setting	04 (Read Register)
0x209C	Minimum gas pressure setting	04 (Read Register)
0x209D	Maximum gas pressure setting	04 (Read Register)
0x209E, 0x209F	Cumulative arc time in seconds	04 (Read Register)
0x0808, 0x0809	Torch lead length	01 (Read Coils)
0x0810	Start switch signal status	01 (Read Coils)
0x0811	Motion switch signal status	01 (Read Coils)
0x0832	Gas test status	05 (Write Single Coil)

List of Powermax SYNC addresses

SYNC Address	Description	Unit	Recommended Modbus Function (hex)	Old Address
Request: Read the ID of the SYNC torch, torch lead, and plasma power supply				
0x3000	Torch and plasma power supply identification High byte: torch ID Low byte: SYNC ID	N/A	04 (Read Registers)	N/A
Request: Read the permitted plasma power supply settings				
0x3001	Permitted operating mode setting High byte: mode high Low byte: mode low	N/A	04 (Read Registers)	N/A
0x3002	Permitted minimum output current (A) setting	Amperes	04 (Read Registers)	0x2099
0x3003	Permitted maximum output current (A) setting	Amperes	04 (Read Registers)	0x209A
0x3004	Permitted minimum gas pressure setting	psi	04 (Read Registers)	0x209C
0x3005	Permitted maximum gas pressure setting	psi	04 (Read Registers)	0x209D
Request: Read the plasma power supply settings				
0x3010	Operating mode setting High byte: 0x00 Low byte: mode	N/A	04 (Read Registers)	N/A
0x3011	Output current (A) setting	Amperes	04 (Read Registers)	N/A
0x3012	Gas pressure setting	psi	04 (Read Registers)	N/A

SYNC Address	Description	Unit	Recommended Modbus Function (hex)	Old Address
Request: Read the actual output of the plasma power supply				
0x3018	Actual output current (A)	Amperes	04 (Read Registers)	N/A
0x3019	Actual gas pressure output at valve	psi	04 (Read Registers)	0x204C
0x301A	Active fault code	N/A	04 (Read Registers)	0x2098
Request: Read the total cut counts for this plasma power supply				
0x3028	Total number of starts (bytes 1 and 0)	Number	04 (Read Registers)	N/A
0x3029	Total number of starts (bytes 3 and 2)		04 (Read Registers)	N/A
0x302A	Cumulative pilot arc time (bytes 1 and 0)	Seconds	04 (Read Registers)	0x209E
0x302B	Cumulative pilot arc time (bytes 3 and 2)		04 (Read Registers)	0x209F
0x302C	Total number of arc transfers (bytes 1 and 0)	Number	04 (Read Registers)	N/A
0x302D	Total number of arc transfers (bytes 3 and 2)		04 (Read Registers)	N/A
0x302E	Cumulative arc transfer time (bytes 1 and 0)	Seconds	04 (Read Registers)	N/A
0x302F	Cumulative arc transfer time (bytes 3 and 2)		04 (Read Registers)	N/A
Request: Read the 16-character unique identification (UID) number for the installed cartridge				
0x3030	UID (bytes 0 and 1)	N/A	04 (Read Registers)	N/A
0x3031	UID (bytes 2 and 3)	N/A	04 (Read Registers)	N/A
0x3032	UID (bytes 4 and 5)	N/A	04 (Read Registers)	N/A
0x3033	UID (bytes 6 and 7)	N/A	04 (Read Registers)	N/A
0x3034	UID (bytes 8 and 9)	N/A	04 (Read Registers)	N/A
0x3035	UID (bytes 10 and 11)	N/A	04 (Read Registers)	N/A
0x3036	UID (bytes 12 and 13)	N/A	04 (Read Registers)	N/A
0x3037	UID (bytes 14 and 15)	N/A	04 (Read Registers)	N/A
Request: Read the part number of the installed cartridge				
0x3038	Part number (bytes 0 and 1)	N/A	04 (Read Registers)	N/A
0x3039	Part number (bytes 2 and 3)	N/A	04 (Read Registers)	N/A
0x303A	Part number (bytes 4 and 5)	N/A	04 (Read Registers)	N/A
0x303B	Part number revision level	N/A	04 (Read Registers)	N/A
Request: Read the amperage for which the installed cartridge is rated				
0x303C	Nominal current	Amperes	04 (Read Registers)	N/A
Request: Read the total cut counts for the installed cartridge				
0x3040	Total number of starts	Number	04 (Read Registers)	N/A
0x3041	Cumulative pilot arc time	Seconds	04 (Read Registers)	N/A
0x3042	Total number of arc transfers	Number	04 (Read Registers)	N/A
0x3043	Cumulative arc transfer time	2 seconds per count	04 (Read Registers)	N/A

SYNC Address	Description	Unit	Recommended Modbus Function (hex)	Old Address
Request: Read the 4 most recent faults for the installed cartridge				
0x3044	Fault log 0 (newest fault)	N/A	04 (Read Registers)	N/A
0x3045	Fault log 1	N/A	04 (Read Registers)	N/A
0x3046	Fault log 2	N/A	04 (Read Registers)	N/A
0x3047	Fault log 3	N/A	04 (Read Registers)	N/A
Request: Read the 12-character name of the installed cartridge				
0x3048	Name (bytes 0 and 1)	N/A	04 (Read Registers)	N/A
0x3049	Name (bytes 2 and 3)	N/A	04 (Read Registers)	N/A
0x304A	Name (bytes 4 and 5)	N/A	04 (Read Registers)	N/A
0x304B	Name (bytes 6 and 7)	N/A	04 (Read Registers)	N/A
0x304C	Name (bytes 8 and 9)	N/A	04 (Read Registers)	N/A
0x304D	Name (bytes 10 and 11)	N/A	04 (Read Registers)	N/A
Request: Write operating settings and put the plasma power supply into remote control mode				
0x3080	Operating mode setting	N/A	10 (Write Multiple Registers)	0x2093
0x3081	Output current (A) setting	Amperes	10 (Write Multiple Registers)	0x2094
0x3082	Gas pressure setting	psi	10 (Write Multiple Registers)	0x2096
Request: Stop fault code 0-50-0				
0x308E	Special quick restart command (Write a value of 0x0404 to this address.)	N/A	10 (Write Multiple Registers)	N/A
0x308F	Special quick restart approval (Write a value of 0x0618 to this address.)	N/A	10 (Write Multiple Registers)	N/A
Request: Read the Start and Motion signal status of the plasma power supply				
0x3100 (coil)	Start switch signal status (ON = 1, OFF = 0)	N/A	01 (Read Coil)	0x0810
0x3101 (coil)	Motion switch signal status (ON = 1, OFF = 0)	N/A	01 (Read Coil)	0x0811
Request: Start and stop a gas test				
0x3180 (coil)	Gas test status (Write a value of 0xFF00 to this coil to start a gas test.) (Write a value of 0x0000 to this coil to stop a gas test.)	N/A	05 (Write Single Coil)	0x0832

Programming recommendations

- **For the best results, use the programming examples that start on page 22 and the flowcharts in *Flowchart Examples* on page 61.** These recommendations give you faster and more reliable communication.
- **Let the Powermax SYNC select the operating settings.** Hypertherm recommends that you let the Powermax SYNC set the operating mode, output current (A), and gas pressure automatically for the installed cartridge.
- **Program the CNC to either automatically identify, or prompt the operator to identify, the plasma power supply type (SYNC or older plasma power supply).** Then use the appropriate register addresses (0x3xxx or 0x2xxx). This lets you reuse the programming on all of your CNCs and cutting tables.
- **Use Modbus function code 04 (Read Input Registers) for Holding Registers *and* Input Registers.** It is not necessary to use Modbus function code 03 (Read Holding Registers) for holding registers. Hypertherm supports this usage to simplify Modbus programming.
- **Send a single request for multiple registers at one time, when possible,** for faster and more reliable communication.
- **Do a check for faults every 1 second.** This is equivalent to doing a check that the plasma power supply is prepared for operation.
- **Do all the recommended steps for all fault codes that occur, including notifications that do not stop the cutting process.** Troubleshooting all faults helps you to get optimal cut quality and consumable life.
- **Program the CNC to log every active fault, including the date and time,** to aid in troubleshooting.
- **Program a response time-out of 60 ms – 100 ms,** to give sufficient time for communication to occur.
- **Program a delay of 50 ms between Start signals,** to give sufficient time for the relay circuits to complete switching.
- **Do not stop gas postflow before it fully completes.** Gas postflow is necessary to decrease the temperature of the cartridge.

Examples of requests and responses

Identify the plasma power supply type (SYNC or older system)

To identify the type of plasma power supply, and therefore the addressing system and features that are available, the CNC must use the following Modbus function code:

- **43/14 (2B/0E)** (Read Device Identification)

Convert the hexadecimal values in the response message to ASCII characters.

Table 2 – Device identifications

Device Identification	Plasma Power Supply Type	Addressing System
303831323838 (hex) 081288 (ASCII)	Powermax45 XP	Old 0x2xxx addresses
303831323233 (hex) 081223 (ASCII)	Powermax65/85/105	Old 0x2xxx addresses
303831323531 (hex) 081251 (ASCII)	Powermax125	Old 0x2xxx addresses
303831333335 (hex) 081335 (ASCII)	Powermax65/85/105 SYNC	New 0x3xxx addresses
303831333437 (hex) 081374 (ASCII)	Powermax45 SYNC	New 0x3xxx addresses

Example request and response

Request from CNC:

```
:012B0E0401C1<CR><LF>
```

Value	Description
:	Start of message
01	Plasma power supply node address
2B0E	Read Device Identification
04	Get 1 specific identification object
01	Starting address
C1	LRC
<CR><LF>	End

Response from plasma power supply:

```
:012B0E0481000101010630383133333504<CR><LF>
```

Value	Description
:	Start of message
01	Plasma power supply node address (confirmed)
2B0E	Read Device Identification (confirmed)
04810001010106	For more information on this segment, refer to <i>Section 6.21 43/14 (0x2B/0x0E) Read Device Identification</i> in the <i>Modbus Application Protocol Specification</i> at modbus.org .
303831333335	303831333335 (hex) = 081335 (ASCII) = Powermax65/85/105 SYNC
04	LRC
<CR><LF>	End

Read the ID of the SYNC torch, torch lead, and plasma power supply

To identify the SYNC torch, torch lead, and plasma power supply, the CNC reads the value in the following register:

- **0x3000** (torch and plasma power supply identification)

0x3000 (torch and plasma power supply identification)

Description:	<p>Reads the binary value of the installed torch type and lead length, and the binary value of the plasma power supply type.</p> <ul style="list-style-type: none"> ▪ High byte: the high byte identifies the torch type and lead length. Refer to <i>Table 3</i>. ▪ Low byte: the low byte identifies the plasma power supply. Refer to <i>Table 4</i>. <p>For example, a response that contains a value of 0508 identifies the following: High byte = 05 = 0x05 (machine torch with 35-foot – 50-foot lead) Low byte = 08 = 0x08 (Powermax105 SYNC CSA 200 V – 600 V)</p>
Encoding or scaling:	N/A
Unit:	N/A
Function (hex):	04 (Read Registers)

Table 3 – Torch type and lead length

High Byte (Torch Type ID)	Torch Type
0x00	Hand torch with 7.6 m (25-foot) lead
0x01	Hand torch with 15 m (50-foot) lead
0x02	Hand torch with 23 m (75-foot) lead
0x04	Machine torch with 4.6 m – 7.6 m (15-foot – 25-foot) lead
0x05	Machine torch with 10.7 m – 15 m (35-foot – 50-foot) lead
0x06	Machine torch with 23 m (75-foot) lead

Table 4 – Plasma power supply type

Low Byte (Type ID)	Plasma Power Supply Type
0x00	Powermax65 SYNC 200 V – 600 V CSA
0x01	Powermax65 SYNC 380 V CCC / 400 V CE
0x02	Powermax85 SYNC 200 V – 600 V CSA
0x03	Powermax85 SYNC 380 V CCC / 400 V CE
0x08	Powermax105 SYNC 200 V – 600 V CSA
0x09	Powermax105 SYNC 230 V – 400 V CE
0x0A	Powermax105 SYNC 380 V CCC / 400 V CE
0x11	Powermax45 SYNC 230 V CSA and CE
0x12	Powermax45 SYNC 400 V CE
0x13	Powermax45 SYNC 480 V CSA

Example request and response

Request from CNC:

```
:010430000001CA<CR><LF>
```

Value	Description
:	Start of message
01	Plasma power supply node address
04	Read Registers
3000	First register address (0x3000)
0001	Quantity of registers to read (0x0001 = 1): <ul style="list-style-type: none"> 0x3000 (torch and plasma power supply identification)
CA	LRC
<CR><LF>	End

Response from plasma power supply:

:0104020508EC<CR><LF>

Value	Description
:	Start of message
01	Plasma power supply node address (confirmed)
04	Read Registers (confirmed)
02	Quantity of bytes in the Data segment (0x02 = 2)
0508	High byte = 05 = 0x05 = machine torch with 35-foot – 50-foot lead Low byte = 08 = 0x08 = Powermax105 SYNC 200 V – 600 V CSA
EC	LRC
<CR><LF>	End

Read the part number of the installed cartridge

To read the part number of the installed cartridge, the CNC reads the values in the following registers:

- **0x3038** (part number, bytes 0 and 1)
- **0x3039** (part number, bytes 2 and 3)
- **0x303A** (part number, bytes 4 and 5)

0x3038, 0x3039, 0x303A (cartridge part number, bytes 0 – 5)

Description:	Identifies the type of machine torch cartridge that is installed by using the cartridge part number. Convert the hexadecimal values in the response message to ASCII characters. Refer to <i>Table 5</i> .
Encoding or scaling:	N/A
Unit:	N/A
Function (hex):	04 (Read Registers)

Table 5 – Machine torch cartridge type

Part Number	Cartridge Type
343238393336 (hex) 428936 (ASCII)	Cut: 105 A cartridge
343238393334 (hex) 428934 (ASCII)	Cut: 85 A cartridge
343238393330 (hex) 428930 (ASCII)	Cut: 65 A cartridge
343238393235 (hex) 428925 (ASCII)	Cut: 45 A cartridge
343238393236 (hex) 428926 (ASCII)	FineCut: 45 A cartridge
343238393339 (hex) 428939 (ASCII)	Max Control gouge: 105 A cartridge
343238393333 (hex) 428933 (ASCII)	Max Control gouge: 65 A / 85 A cartridge
343238393239 (hex) 428929 (ASCII)	Max Control gouge: 45 A cartridge (Powermax65/85/105 SYNC only)
343238393338 (hex) 428938 (ASCII)	Max Removal gouge: 105 A cartridge
343238393332 (hex) 428932 (ASCII)	Max Removal gouge: 45 A / 65 A / 85 A cartridge
000000000000 (hex) 000000 (ASCII)	Cartridge communication failure or radio frequency error

Example request and response

Request from CNC:

```
:01043038000390<CR><LF>
```

Value	Description
:	Start of message
01	Plasma power supply node address
04	Read Registers
3038	First register address
0003	Quantity of registers to read (0x0003 = 3): <ul style="list-style-type: none"> ▪ 0x3038 (part number, bytes 0 and 1) ▪ 0x3039 (part number, bytes 2 and 3) ▪ 0x303A (part number, bytes 4 and 5)
90	LRC
<CR><LF>	End

Response from plasma power supply:

```
:010406343238393336B5<CR><LF>
```

Value	Description
:	Start of message
01	Plasma power supply node address (confirmed)
04	Read Registers (confirmed)
06	Quantity of bytes in the Data segment (0x06 =6)
343238393336	343238393336 (hex) = 428936 (ASCII) = 105 A cut cartridge
B5	LRC
<CR><LF>	End

Read the plasma power supply settings that are permitted for the installed cartridge

To read the plasma power supply settings that are permitted for the installed cartridge, the CNC reads the values in the following registers:

- **0x3001** (permitted operating mode setting)
- **0x3002** (permitted minimum output current (A) setting)
- **0x3003** (permitted maximum output current (A) setting)
- **0x3004** (permitted minimum gas pressure setting)
- **0x3005** (permitted maximum gas pressure setting)

0x3001 (permitted operating mode setting)

Description:	Reads the operating mode settings that are permitted for the installed cartridge. Valid values are as follows: <ul style="list-style-type: none">▪ 0x01 (cut)▪ 0x02 (expanded metal) - Powermax65/85/105 SYNC only▪ 0x03 (gouge)
Encoding or scaling:	16-bit, fixed-point binary with 1-bit sign at MSB and 0-bit decimal at LSB
Unit:	N/A
Function (hex):	04 (Read Registers)

0x3002, 0x3003 (permitted minimum and maximum output current (A) settings)

Description:	Read the hexadecimal values for the minimum and maximum output current (A) settings that are permitted for the installed cartridge. Convert the hexadecimal value to decimal, and then divide that decimal value by 64 to get the output current (A).
Encoding or scaling:	16-bit, fixed-point binary with 1-bit sign at MSB and 6-bit decimal at LSB
Unit:	Amperes
Function (hex):	04 (Read Registers)

0x3004, 0x3005 (permitted minimum and maximum gas pressure settings)

Description:	Reads the hexadecimal values for the minimum and maximum gas pressure (psi) settings for the installed cartridge, torch, and plasma power supply. Convert the hexadecimal value to decimal, and then divide that decimal value by 128 to get the gas pressure (psi).
Encoding or scaling:	16-bit, fixed-point binary with 1-bit sign at MSB and 7-bit decimal at LSB
Unit:	N/A
Function (hex):	04 (Read Registers)

Example request and response

Request from CNC:

```
:010430010005C5<CR><LF>
```

Value	Description
:	Start of message
01	Plasma power supply node address
04	Read Registers
3001	First register address
0005	Quantity of registers to read (0x0005 =5): <ul style="list-style-type: none"> ▪ 0x3001 (permitted operating mode setting) ▪ 0x3002 (permitted minimum output current (A) setting) ▪ 0x3003 (permitted maximum output current (A) setting) ▪ 0x3004 (permitted minimum gas pressure setting) ▪ 0x3005 (permitted maximum gas pressure setting)
C5	LRC
<CR><LF>	End

Response from plasma power supply:

```
:01040A020107800B401D002700D8<CR><LF>
```

Value	Description
:	Start of message
01	Plasma power supply node address (confirmed)
04	Read Registers (confirmed)
0A	Quantity of bytes in the Data segment (0x0A = 10)
0201	02 = 0x02 = expanded metal (Powermax65/85/105 SYNC only) 01 = 0x01 = cut
0780	0x0780 = 1920/64 = 30 A
0B40	0x0B40 = 2880/64 = 45 A
1D00	0x1D00 = 7424/128 = 58 psi
2700	0x2700 = 9984/128 = 78 psi
D8	LRC
<CR><LF>	End

Write operating settings and put the plasma power supply into remote control mode



This write request is not necessary if you let the Powermax SYNC automatically set the operating settings. Hypertherm strongly recommends that you let the Powermax SYNC set the operating settings. Refer to *Programming recommendations* on page 21.

To override automatic settings and put the Powermax SYNC into remote control mode, the CNC must write values to the following registers:

- **0x3080** (operating mode setting)
- **0x3081** (output current (A) setting)
- **0x3082** (gas pressure setting)



To avoid 0-11-*n* faults, make sure to write to all 3 registers in 1 request.

0x3080 (operating mode setting)

Description:	Sets the operating mode. The following values are permitted: <ul style="list-style-type: none"> ▪ 0x0001 (cut) ▪ 0x0002 (expanded metal) - Powermax65/85/105 SYNC only ▪ 0x0003 (gouge)
Encoding or scaling:	16-bit, fixed-point binary with 1-bit sign at MSB and 0-bit decimal at LSB
Unit:	N/A
Functions (hex):	10 (Write Multiple Registers) (recommended) Also supported: 06 (Write Single Register)

0x3081 (output current (A) setting)

Description:	Sets the output current (A). To specify the output current (A) that you want: Multiply the output current (A) that you want by 64, and convert the product to its hexadecimal value. For example, to set the output current (A) to 65 A: $65 \times 64 = 4160 = 0x1040$
Encoding or scaling:	16-bit, fixed-point binary with 1-bit sign at MSB and 6 bit decimal at LSB
Unit:	Amperes
Function (hex):	10 (Write Multiple Registers) (recommended) Also supported: 06 Write Single Register

0x3082 (gas pressure setting)

Description:	Sets the gas pressure in psi. To have the plasma power supply set the gas pressure automatically: Write a value of zero (0x0000) to address 0x3082. The plasma power supply will automatically set the gas pressure for optimum cutting related to the operating mode, the torch type, the cartridge type, and the length of the torch lead. To specify the gas pressure (psi) that you want: Multiply the gas pressure (psi) that you want by 128, and convert the product to its hexadecimal value. For example, to set the gas pressure to 45 psi: $45 \times 128 = 5760 = 0x1680$
Encoding or scaling:	16-bit, fixed-point binary with 1-bit sign at MSB and 7-bit decimal at LSB
Unit:	psi
Function (hex):	10 (Write Multiple Registers) (recommended) Also supported: 06 (Write Single Register)

Example request and response

In this example, you want to put the Powermax SYNC into remote control mode and cut at 63 A, with gas pressure set automatically by the plasma power supply.

Request from CNC:

```
:0110308000030600010FC0000066<CR><LF>
```

Value	Description
:	Start of message
01	Plasma power supply node address
10	Write Multiple Registers
3080	First register address (0x3080)
0003	Quantity of registers to write (0x0003 = 3): <ul style="list-style-type: none"> ▪ 0x3080 (operating mode) ▪ 0x3081 (output current (A)) ▪ 0x3082 (gas pressure)
06	Quantity of bytes in the Data segment (0x06 = 6)
0001	Value to write to address 0x3080: 0x0001 = Cut mode
0FC0	Value to write to address 0x3081: $63 \text{ A} \times 64 = 4032 = 0x0FC0$
0000	Value to write to address 0x3082 (0x0000 = automatic)
66	LRC
<CR><LF>	End

Response from plasma power supply:

:0110308000033C<CR><LF>

Value	Description
:	Start of message
01	Plasma power supply node address (confirmed)
10	Write Multiple Registers (confirmed)
3080	First register address (confirmed)
0003	Quantity of registers to write (confirmed)
3C	LRC
<CR><LF>	End

Refer also to *Exit remote control mode* on page 41.

Remote control mode indicator on the plasma power supply

When the plasma power supply enters remote control mode, an indicator shows on the LCD display.

The front panel controls are disabled when the plasma power supply is in remote control mode. Fault codes and fault icons still show, and you can still go to the menu screens (Powermax65/85/105 SYNC) to see information about the plasma power supply, torch, and cartridge.

Refer also to *Exit remote control mode* on page 41.

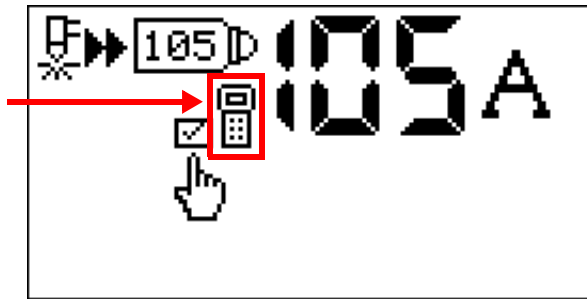

Powermax65/85/105 SYNC

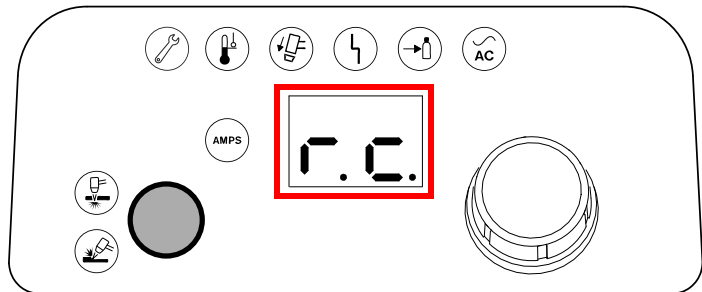

Powermax45 SYNC

Do a check for an active fault

Active faults must be resolved before cutting can start. To do a check for an active fault, the CNC reads the value in the following register:

- **0x301A** (active fault code)

If there is no active fault, the CNC can start cutting.

0x301A (active fault code)

Description:	Reads the hexadecimal value of the fault code for a fault that is currently active on the plasma power supply. If there is no active fault, this reads a value of 0x0000 (0-00-0). Refer to <i>Fault code list</i> on page 34 for the complete list of possible fault codes.
Encoding or scaling:	10-bit effective unsigned binary number from the LSB of a 16-bit binary number
Unit:	N/A
Function (hex):	04 (Read Registers)

Example request and response

Request from CNC:

```
:0104301A0001B0<CR><LF>
```

Value	Description
:	Start of message
01	Plasma power supply node address
04	Read Registers
301A	First register address (0x301A)
0001	Quantity of registers to read (0x0001 = 1): <ul style="list-style-type: none"> ▪ 0x301A (active fault code)
B0	LRC
<CR><LF>	End

Response from plasma power supply:

```
:01040201F404<CR><LF>
```

Value	Description
:	Start of message
01	Plasma power supply node address (confirmed)
04	Read Registers (confirmed)
02	Quantity of bytes in the Data segment (2)

01F4 0x01F4 = 500 (fault code 0-50-0)
 The cartridge is off the torch. Or, the cartridge was
 removed with the torch-disable switch set to the
 green "ready to fire" (✓) position.

04 LRC

<CR><LF> End

Fault code list

Table 6 lists all of the possible Powermax SYNC fault codes and brief descriptions. For more information about how to identify and troubleshoot each fault condition, refer to the *Powermax65/85/105 SYNC Troubleshooting Guide (810430)* and the *Powermax45 SYNC Operator Manual (811470)*.

Table 6 – Fault codes and descriptions

Fault Code	Fault Code (hex)	Fault Code (decimal)	Description	Steps Required to Remove?
Operational faults				
-	0000	0	There is no active fault.	No
0-11-0	006E	110	The operating mode is incorrect or not permitted for the installed cartridge.	No, but recommended
0-11-1	006F	111	The output current (A) is incorrect or not permitted for the installed cartridge.	No, but recommended
0-11-2	0070	112	The gas pressure is incorrect or not permitted. The permitted gas pressure relates to the selected process and operating mode, and to the installed torch, torch lead, and cartridge.	
0-12-1	0079	121	The gas pressure output is low.	No, but recommended
0-12-2	007A	122	The gas pressure output is high.	No, but recommended
0-12-3	007B	123	The gas pressure output is not stable.	No, but recommended
0-13-0	0082	130	The alternating current (AC) input power is not stable.	No, but recommended
0-14-0	008C	140	There is a problem with the cartridge installation. The cartridge cannot send data to the plasma power supply.	Yes
0-14-1	008D	141	The cartridge is not recognized.	No, but recommended
0-19-9	00C7	199	The input power stopped. Or, power PCB hardware protection occurred for components in the plasma power supply.	Yes
0-20-0	00C8	200	The gas pressure is lower than the minimum pressure for the selected process, operating mode, torch, lead length, and cartridge type.	No, but recommended

Fault Code	Fault Code (hex)	Fault Code (decimal)	Description	Steps Required to Remove?
0-21-0	00D2	210	(Powermax65/85/105 SYNC) The gas flow stopped during cutting (an excessive change to arc voltage occurred).	Yes
0-22-0	00DC	220	There is no gas supply input.	Yes
0-30-0	012C	300	There is a torch stuck open (TSO) condition.	Yes
0-30-1	012D	301	There is a torch stuck closed (TSC) condition.	Yes
0-32-0	0140	320	(Powermax65/85/105 SYNC) The system sensed that the cartridge in use is at end-of-life.	Yes
0-32-1	0141	321	A cartridge is installed that had the 0-32-0 fault before and is at end-of-life.	No, but recommended
0-40-0	0190	400	The boost power-factor correction insulated-gate bipolar-transistor (PFC IGBT) is too cold. This is applicable to CSA and CE/CCC 230 V – 400 V models only.	Yes
0-40-1	0191	401	The boost PFC IGBT is too hot. This is applicable to CSA and CE/CCC 230 V – 400 V models only.	Yes
0-40-2	0192	402	The inverter IGBT is too cold.	Yes
0-40-3	0193	403	The inverter IGBT is too hot.	Yes
0-40-4	0194	404	(Powermax45 SYNC) An internal temperature communication failure occurred.	Yes
0-40-5	0195	405	(Powermax45 SYNC) Duty cycle exceeded.	Yes
0-50-0	01F4	500	The cartridge is off, the torch was disconnected when you set the plasma power supply to ON (I), or the torch was in the yellow lock (X) position during a restart.	Yes
0-50-1	01F5	501	The torch-lock switch is set to the yellow lock (X) position.	Yes
0-50-2	01F6	502	The torch-lock switch is set to the green “ready to fire” () position, but the torch is not prepared to fire. ✓	No
0-50-3	01F7	503	This code shows momentarily while the system reads data from the cartridge.	No
0-51-0	01FE	510	The plasma power supply was receiving a signal to start cutting at the same time that the power switch was set to ON (I). This is sometimes referred to as a “stuck start.”	Yes
0-52-0	0208	520	The torch is not connected.	Yes
0-60-0	0258	600	An AC input voltage phase loss occurred.	Yes

Fault Code	Fault Code (hex)	Fault Code (decimal)	Description	Steps Required to Remove?
0-60-1	0259	601	The AC input voltage is too low.	Yes
0-60-2	025A	602	The AC input voltage is too high.	Yes
0-61-0	0262	610	The AC input is not stable.	Yes
0-98-0	03D4	980	(Powermax65/85/105 SYNC) An internal communication failure occurred between the LCD/control PCB and the DSP PCB.	No, but recommended
0-98-1	03D5	981	A radio frequency (RF) communication failure occurred between the cartridge and the torch.	No, but recommended
0-98-2	03D6	982	A communication failure occurred between the torch and the plasma power supply.	No, but recommended
Internal component faults				
1-00-0	03E8	1000	A digital-signal processor (DSP) PCB fault occurred.	Yes
1-20-0	04B0	1200	An input/output (I/O) fault occurred.	Yes
1-30-0	0514	1300	(Powermax65/85/105 SYNC) A flash memory fault occurred.	Yes
2-00-0	07D0	2000	The analog-to-digital converter (ADC) value is out of range.	Yes
2-01-0	07DA	2010	(Powermax65/85/105 SYNC) The auxiliary switch is disconnected.	Yes
2-10-0	0834	2100	The inverter IGBT temperature sensor is open.	Yes
2-10-1	0835	2101	The inverter IGBT temperature sensor short-circuited.	Yes
2-11-0	083E	2110	The pressure sensor is open.	Yes
2-11-1	083F	2111	The pressure sensor short-circuited.	Yes
2-20-0	0898	2200	(Powermax65/85/105 SYNC) The DSP PCB does not recognize the torch.	Yes
3-00-0	0BB8	3000	The DC bus voltage (VBUS) is out of range.	Yes
3-10-0	0C1C	3100	The fan speed is less than the minimum speed.	Yes
3-10-1	0C1D	3101	A fan fault occurred.	Yes
3-11-0	0C26	3110	The PFC IGBT temperature sensor is open.	Yes
3-11-1	0C27	3111	The PFC IGBT temperature sensor short-circuited.	Yes
3-11-2	0C28	3112	There is a PFC IGBT temperature sensor circuit fault.	Yes
3-20-0	0C80	3200	(Powermax65/85/105 SYNC) The fill valve is not connected.	Yes
3-20-1	0C81	3201	(Powermax65/85/105 SYNC) The dump valve is not connected.	Yes

Fault Code	Fault Code (hex)	Fault Code (decimal)	Description	Steps Required to Remove?
3-20-2	0C82	3202	(Powermax65/85/105 SYNC) The plasma power supply does not recognize the solenoid valve electronic regulator.	Yes
3-20-3	0C83	3203	(Powermax65/85/105 SYNC) The solenoid valve electronic regulator is not receiving power.	Yes
3-41-0	0D52	3410	(Powermax65/85/105 SYNC) A driver integrated circuit (IC) fault occurred.	Yes
3-42-0	0D5C	3420	(Powermax65/85/105 SYNC) The 5 VDC or 24 VDC supply is out of range.	Yes
3-42-1	0D5D	3421	(Powermax65/85/105 SYNC) The 18 VDC supply is out of range.	Yes
3-43-0	0D66	3430	(Powermax65/85/105 SYNC) The inverter capacitors are not balanced.	Yes
3-44-1	0D71	3441	(Powermax65/85/105 SYNC) The PFC IGBT current is too high.	Yes
3-51-1	0DB7	3511	An inverter IGBT saturation fault occurred. The inverter current is too high.	Yes
3-52-0	0DC0	3520	A short-circuit caused high-current distortion in the inverter IGBT. This is sometimes referred to as a shoot-through.	Yes
3-60-0	0E10	3600	The DSP PCB does not recognize the power PCB.	Yes
3-70-0	0E74	3700	(Powermax65/85/105 SYNC) There is an internal serial communications fault between the DSP PCB and power PCB.	Yes

Start and stop a gas test

To start and stop a gas test, the CNC must write a value to the following coil:

- **0x3180** (coil: gas test)

0x3180 (coil: gas test)

Description: Write a value for ON or OFF to this coil to start or stop a gas test.

- Write 0xFF00 (ON) to start a gas test.
- Write 0x0000 (OFF) to stop a gas test.

Encoding or scaling: N/A

Unit: N/A

Function (hex): 05 (Write Single Coil)

Example request and response

Request from CNC to start a gas test:

:01053180FF004A<CR><LF>

Value	Description
:	Start of message
01	Plasma power supply node address
05	Write Single Coil
3180	Coil address (0x3180)
FF00	Value to write to coil address 0x3180 (0xFF00 = ON)
4A	LRC
<CR><LF>	End

Response from plasma power supply:

:01053180FF004A<CR><LF>

Value	Description
:	Start of message
01	Plasma power supply node address (confirmed)
05	Write Single Coil (confirmed)
3180	Coil address (0x3180) (confirmed)
FF00	Value to write to coil address 0x3180 (0xFF00 = ON) (confirmed)
4A	LRC
<CR><LF>	End

Request from CNC to stop a gas test:

:01053180000049<CR><LF>

Value	Description
:	Start of message
01	Plasma power supply node address
05	Write Single Coil
3180	Coil address (0x3180)
0000	Value to write to coil address 0x3180 (0x0000 = OFF)
49	LRC
<CR><LF>	End

Response from plasma power supply:

:01053180000049<CR><LF>

Value	Description
:	Start of message
01	Plasma power supply node address (confirmed)
05	Write Single Coil (confirmed)
3180	Coil address (0x3180) (confirmed)
0000	Value to write to coil address 0x3180 (0x0000 = OFF) (confirmed)
49	LRC
<CR><LF>	End

Stop fault code 0-50-0

Before you change a cartridge, you must set the torch-disable switch to the yellow lock (X) position. Otherwise you get fault code 0-50-0 (the cartridge is off the torch). To stop fault code 0-50-0 after you install the new cartridge, The CNC must write values to the following registers:

- **0x308E** (command to stop fault code 0-50-0 with a special quick restart)
- **0x308F** (special quick restart approval)



To give sufficient time for the plasma power supply to complete the restart, wait 2 seconds before you send a new read or write request.



This special quick restart only stops fault code 0-50-0. You cannot stop other fault codes with this special quick restart.

0x308E, 0x308F (stop fault code 0-50-0 with a quick restart)

Description:	Write a value of 0x0404 to address 0x308E and a value of 0x0618 to address 0x308F to do a special quick restart that stops fault code 0-50-0.
Encoding or scaling:	N/A
Unit:	N/A
Function (hex):	10 (Write Multiple Registers)

Example request and response

Request from CNC:

:0110308E0002040404061805<CR><LF>

Value	Description
:	Start of message
01	Plasma power supply node address
10	Write Multiple Registers
308E	First register address (0x308E)
0002	Quantity of registers to write (0x002 = 2): <ul style="list-style-type: none">▪ 0x308E (special quick restart command)▪ 0x308F (special quick restart approval)
04	Quantity of bytes in the Data segment (0x04 = 4)
0404	Value to write to address 0x308E (0x0404 = special quick restart)
0618	Value to write to address 0x308F (0x0618 = approval)
05	LRC
<CR><LF>	End

Response from plasma power supply:

:0110308E00022F<CR><LF>

Value	Description
:	Start of message
01	Plasma power supply node address (confirmed)
10	Write Multiple Registers (confirmed)
308E	Register address (confirmed)
0002	Quantity of registers to write (confirmed)
2F	LRC
<CR><LF>	End

Exit remote control mode

To exit remote control mode, the CNC must write a value of zero (0x0000) to the following registers (the same registers used to enter remote control mode):

- **0x3080** (operating mode setting)
- **0x3081** (output current (A) setting)
- **0x3082** (gas pressure setting)

Example request and response

Request from CNC:

```
:01103080000306000000000000036<CR><LF>
```

Value	Description
:	Start of message
01	Plasma power supply node address
10	Write Multiple Registers
3080	First register address (0x3080)
0003	Quantity of registers to write (0x0003 = 3): <ul style="list-style-type: none"> ▪ 0x3080 (operating mode) ▪ 0x3081 (output current) ▪ 0x3082 (gas pressure)
06	Quantity of bytes in the Data segment (0x06 = 6)
0000	Value to write to address 0x3080 (0x0000)
0000	Value to write to address 0x3081 (0x0000)
0000	Value to write to address 0x3082 (0x0000)
36	LRC
<CR><LF>	End

Response from plasma power supply:

```
:0110308000033C<CR><LF>
```

Value	Description
:	Start of message
01	Plasma power supply node address (confirmed)
10	Write Multiple Registers (confirmed)
3080	First register address (confirmed)
0003	Quantity of registers to write (confirmed)
3C	LRC
<CR><LF>	End

When the Powermax SYNC exits remote control mode, the remote mode indicator no longer shows on the LCD display. Refer to page 32.



You can also stop remote control mode by setting the power switch on the plasma power supply to the OFF (O) position and waiting approximately 1 minute.

Get data from the plasma power supply

Read the plasma power supply settings

To read the plasma power supply settings, the CNC reads the values in the following registers:

- **0x3010** (operating mode setting)
- **0x3011** (output current (A) setting)
- **0x3012** (gas pressure setting)

0x3010 (operating mode)

Description:	Reads the operating mode setting. Valid values are as follows: <ul style="list-style-type: none">▪ 0x0001 (cut)▪ 0x0002 (expanded metal) - Powermax65/85/105 SYNC only▪ 0x0003 (gouge)
Encoding or scaling:	16-bit, fixed-point binary with 1-bit sign at MSB and 0-bit decimal at LSB
Unit:	N/A
Function (hex):	04 (Read Registers)

0x3011 (output current (A) setting)

Description:	Reads the hexadecimal value for the output current (A) setting. Convert the hexadecimal value to decimal, and then divide that decimal value by 64 to get the output current (A).
Encoding or scaling:	16-bit, fixed-point binary with 1-bit sign at MSB and 6 bit decimal at LSB
Unit:	Amperes
Function (hex):	04 (Read Registers)

0x3012 (gas pressure setting)

Description:	Reads the hexadecimal value for the gas pressure setting in psi. Convert the hexadecimal value to decimal, and then divide that decimal value by 128 to get the gas pressure (psi).
Encoding or scaling:	16-bit, fixed-point binary with 1-bit sign at MSB and 7-bit decimal at LSB
Unit:	psi
Function (hex):	04 (Read Registers)

Example request and response**Request from CNC:**

```
:010430100003B8<CR><LF>
```

Value	Description
:	Start of message
01	Plasma power supply node address
04	Read Registers
3010	First register address (0x3010)
0003	Quantity of registers to read (0x0003 = 3): <ul style="list-style-type: none"> ▪ 0x3010 (operating mode setting) ▪ 0x3011 (output current (A) setting) ▪ 0x3012 (gas pressure setting)
B8	LRC
<CR><LF>	End

Response from plasma power supply:

```
:01040600011A40260074<CR><LF>
```

Value	Description
:	Start of message
01	Plasma power supply node address (confirmed)
04	Read Registers (confirmed)
06	Quantity of bytes in the Data segment (0x06 = 6)
00 01	00 = 0x00 = high byte 01 = 0x01 = cut
1A40	0x1A40 = 6720/64 = 105 A
2600	0x2600 = 9728/128 = 76 psi
74	LRC
<CR><LF>	End

Read the actual output of the plasma power supply

To read the actual output of the plasma power supply, the CNC reads the values in the following registers:

- **0x3018** (actual output current)
- **0x3019** (actual gas pressure)

0x3018 (actual output current)

Description:	Reads the hexadecimal value for the actual output current (A). Convert the hexadecimal value to decimal, and then divide that decimal value by 64 to get the output current (A).
Encoding or scaling:	16-bit, fixed-point binary with 1-bit sign at MSB and 6 bit decimal at LSB
Unit:	Amperes
Function (hex):	04 (Read Registers)

0x3019 (actual gas pressure)

Description:	Reads the hexadecimal value for the actual gas pressure in psi. Convert the hexadecimal value to decimal, and then divide that decimal value by 128 to get the gas pressure (psi).
Encoding or scaling:	16-bit, fixed-point binary with 1-bit sign at MSB and 7-bit decimal at LSB
Unit:	psi
Function (hex):	04 (Read Registers)

Example request and response

Request from CNC:

```
:010430180002B1<CR><LF>
```

Value	Description
:	Start of message
01	Plasma power supply node address
04	Read Registers
3018	First register address (0x3018)
0002	Quantity of registers to read (0x0002 = 2): <ul style="list-style-type: none"> ▪ 0x3018 (actual output current) ▪ 0x3019 (actual gas pressure)
B1	LRC
<CR><LF>	End

Response from plasma power supply:

:010404104023DDA7<CR><LF>

Value	Description
:	Start of message
01	Plasma power supply node address (confirmed)
04	Read Registers (confirmed)
04	Quantity of bytes in the Data segment (0x04 = 4)
1040	0x1040 = 4160/64 = 65 A
23DD	0x23DD = 9181/128 = 72 psi
A7	LRC
<CR><LF>	End

Read the total cut counts for this plasma power supply

To read the total cut counts for this plasma power supply, the CNC reads the values in the following registers:

- **0x3028** (total number of torch starts – bytes 1 and 0)
- **0x3029** (total number of torch starts – bytes 3 and 2)
- **0x302A** (cumulative pilot arc time – bytes 1 and 0)
- **0x302B** (cumulative pilot arc time – bytes 3 and 2)
- **0x302C** (total number of arc transfers – bytes 1 and 0)
- **0x302D** (total number of arc transfers – bytes 3 and 2)
- **0x302E** (cumulative arc transfer time – bytes 1 and 0)
- **0x302F** (cumulative arc transfer time – bytes 3 and 2)

0x3028 (total number of torch starts – bytes 1 and 0)

Description:	Reads the hexadecimal value of the low word (bytes 1 and 0) for the total number of torch starts that the plasma power supply has done in its life. Refer to <i>0x3029 (total number of starts – bytes 3 and 2)</i> .
Encoding or scaling:	32-bit unsigned binary number
Unit:	Number
Function (hex):	04 (Read Registers)

0x3029 (total number of starts – bytes 3 and 2)

Description:	Reads the hexadecimal value of the high word (bytes 3 and 2) for the total number of torch starts that the plasma power supply has done in its life. You will need to interchange the hexadecimal values for 0x3028 and 0x3029, and then convert the result to decimal.
Encoding or scaling:	32-bit unsigned binary number
Unit:	Number
Function (hex):	04 (Read Registers)

0x302A (cumulative pilot arc time – bytes 1 and 0)

Description:	Reads the hexadecimal value of the low word (bytes 1 and 0) for the cumulative pilot arc time in seconds that the plasma power supply has had in its life. Refer to <i>0x302B (cumulative pilot arc time – bytes 3 and 2)</i> .
Encoding or scaling:	32-bit unsigned binary number
Unit:	Seconds
Function (hex):	04 (Read Registers)

0x302B (cumulative pilot arc time – bytes 3 and 2)

Description:	Reads the hexadecimal value of the high word (bytes 3 and 2) for the cumulative pilot arc time in seconds that the plasma power supply has had in its life. You will need to interchange the hexadecimal values for 0x302A and 0x302B, and then convert the result to decimal.
Encoding or scaling:	32-bit unsigned binary number
Unit:	Seconds
Function (hex):	04 (Read Registers)

0x302C (total number of arc transfers – bytes 1 and 0)

Description:	Reads the hexadecimal value of the low word (bytes 1 and 0) for the total number of arc transfers that the plasma power supply has done in its life. Refer to <i>0x302D (total number of arc transfers – bytes 3 and 2)</i> .
Encoding or scaling:	32-bit unsigned binary number
Unit:	Number
Function (hex):	04 (Read Registers)

0x302D (total number of arc transfers – bytes 3 and 2)

Description:	Reads the hexadecimal value of the high word (bytes 3 and 2) for the total number of arc transfers that the plasma power supply has done in its life. You will need to interchange the hexadecimal values for 0x302C and 0x302D, and then convert the result to decimal.
Encoding or scaling:	32-bit unsigned binary number
Unit:	Number
Function (hex):	04 (Read Registers)

0x302E (cumulative arc transfer time – bytes 1 and 0)

Description:	Reads the hexadecimal value of the low word (bytes 1 and 0) for the cumulative arc transfer time in seconds that the plasma power supply has had in its life. Refer to <i>0x302F (cumulative arc transfer time – bytes 3 and 2)</i> .
Encoding or scaling:	32-bit unsigned binary number
Unit:	Seconds
Function (hex):	04 (Read Registers)

0x302F (cumulative arc transfer time – bytes 3 and 2)

Description:	Reads the hexadecimal value of the high word (bytes 3 and 2) for the cumulative arc transfer time in seconds that the plasma power supply has had in its life. You will need to interchange the hexadecimal values for 0x302E and 0x302F, and then convert the result to decimal.
Encoding or scaling:	32-bit unsigned binary number
Unit:	Seconds
Function (hex):	04 (Read Registers)

Example request and response

Request from CNC:

:0104302800089B<CR><LF>

Value	Description
:	Start of message
01	Plasma power supply node address
04	Read Registers
3028	First register address (0x3028)
0008	Quantity of registers to read (0x0008 = 8): <ul style="list-style-type: none"> ▪ 0x3028 (total number of torch starts – bytes 1 and 0) ▪ 0x3029 (total number of torch starts – bytes 3 and 2) ▪ 0x302A (cumulative pilot arc time – bytes 1 and 0) ▪ 0x302B (cumulative pilot arc time – bytes 3 and 2) ▪ 0x302C (total number of arc transfers – bytes 1 and 0) ▪ 0x302D (total number of arc transfers – bytes 3 and 2) ▪ 0x302E (cumulative arc transfer time – bytes 1 and 0) ▪ 0x302F (cumulative arc transfer time – bytes 3 and 2)
9B	LRC
<CR><LF>	End

Response from plasma power supply:

:010410D1B6000010EB0000D0750000D5AE00069B<CR><LF>

Value	Description
:	Start of message
01	Plasma power supply node address (confirmed)
04	Read Registers (confirmed)
10	Quantity of bytes in the Data segment (0x10 = 16)
D1B6 0000	D1B6 0000 = 0x0000D1B6 = 53,686 starts
10EB 0000	10EB 0000 = 0x000010EB = 4,331 seconds of pilot arc (72 minutes)
D075 0000	D075 0000 = 0x0000D075 = 53,365 arc transfers
D5AE 0006	D5AE 0006 = 0x0006D5AE = 447,918 seconds of arc transfer (124 hours)
9B	LRC
<CR><LF>	End

Read the 16-character UID number for the installed cartridge

To read the unique identification (UID) number for the installed cartridge, the CNC reads the values in the following registers:

- **0x3030** (UID, bytes 0 and 1)
- **0x3031** (UID, bytes 2 and 3)
- **0x3032** (UID, bytes 4 and 5)
- **0x3033** (UID, bytes 6 and 7)
- **0x3034** (UID, bytes 8 and 9)
- **0x3035** (UID, bytes 10 and 11)
- **0x3036** (UID, bytes 12 and 13)
- **0x3037** (UID, bytes 14 and 15)

0x3030 – 0x3037 (cartridge UID, bytes 0 – 15)

Description:	<p>Reads the hexadecimal value for the 16-character ASCII UID for the installed cartridge.</p> <p>Convert the hexadecimal values to ASCII.</p> <p>A hexadecimal value of 00000000000000000000000000000000 indicates a cartridge communication failure or radio frequency error.</p>
Encoding or scaling:	N/A
Unit:	N/A
Function (hex):	04 (Read Registers)

Example request and response

Request from CNC:

:01043030000893<CR><LF>

Value	Description
:	Start of message
01	Plasma power supply node address
04	Read Registers
3030	First register address (0x3030)
0008	Quantity of registers to read (0x0008 = 8): <ul style="list-style-type: none"> ▪ 0x3030 (UID, bytes 0 and 1) ▪ 0x3031 (UID, bytes 2 and 3) ▪ 0x3032 (UID, bytes 4 and 5) ▪ 0x3033 (UID, bytes 6 and 7) ▪ 0x3034 (UID, bytes 8 and 9) ▪ 0x3035 (UID, bytes 10 and 11) ▪ 0x3036 (UID, bytes 12 and 13) ▪ 0x3037 (UID, bytes 14 and 15)
93	LRC
<CR><LF>	End

Response from plasma power supply:

:0104104530303430314430303336464232354471<CR><LF>

Value	Description
:	Start of message
01	Plasma power supply node address (confirmed)
04	Read Registers (confirmed)
10	Quantity of bytes in the Data segment (0x10 = 16)
45303034303144303033364642323544	= E00401D0036FB25D (ASCII)
71	LRC
<CR><LF>	End

Read the total cut counts for the installed cartridge

To read the total cut counts for the installed cartridge, the CNC reads the values in the following registers:

- **0x3040** (total number of starts)
- **0x3041** (cumulative pilot arc time)
- **0x3042** (total number of arc transfers)
- **0x3043** (cumulative arc transfer time)

0x3040 (total number of starts)

Description:	Reads the hexadecimal value for the total number of pilot arc starts that the cartridge has done in its life. Convert the hexadecimal value to decimal.
Encoding or scaling:	16-bit unsigned binary number
Unit:	N/A
Function (hex):	04 (Read Registers)

0x3041 (cumulative pilot arc time)

Description:	Reads the hexadecimal value for the cumulative pilot arc time in seconds that the cartridge has had in its life. Convert the hexadecimal value to decimal.
Encoding or scaling:	16-bit unsigned binary number
Unit:	N/A
Function (hex):	04 (Read Registers)

0x3042 (total number of arc transfers)

Description:	Reads the hexadecimal value for the total number of arc transfers that the cartridge has done in its life. Convert the hexadecimal value to decimal.
Encoding or scaling:	16-bit unsigned binary number
Unit:	N/A
Function (hex):	04 (Read Registers)

0x3043 (cumulative arc transfer time)

Description:	Reads the hexadecimal value for the cumulative arc transfer time in seconds that the cartridge has had in its life. Each count equals 2 seconds. Convert the hexadecimal value to decimal, and multiply by 2.
Encoding or scaling:	16-bit unsigned binary number
Unit:	N/A
Function (hex):	04 (Read Registers)

Example request and response

Request from CNC:

:01043040000487<CR><LF>

Value	Description
:	Start of message
01	Plasma power supply node address
04	Read Registers
3040	First register address (0x3040)
0004	Quantity of registers to read (0x0004 = 4): <ul style="list-style-type: none">▪ 0x3040 (total number of starts)▪ 0x3041 (cumulative pilot arc time)▪ 0x3042 (total number of arc transfers)▪ 0x3043 (cumulative arc transfer time)
87	LRC
<CR><LF>	End

Response from plasma power supply:

:01040800D6000900D3098FA9<CR><LF>

Value	Description
:	Start of message
01	Plasma power supply node address (confirmed)
04	Read Registers (confirmed)
08	Quantity of bytes in the Data segment (0x08 = 8)
00D6	0x00D6 = 214 starts
0009	0x0009 = 9 seconds of pilot arc
00D3	0x00D3 = 211 arc transfers
098F	0x098F = 2,447 X 2 = 4,894 seconds of arc transfer (82 minutes)
A9	LRC
<CR><LF>	End

Read the 4 most recent faults for the installed cartridge

To read the 4 most recent faults for the installed cartridge, the CNC reads the values in the following registers:

- **0x3044** (fault log 0 – newest fault)
- **0x3045** (fault log 1)
- **0x3046** (fault log 2)
- **0x3047** (fault log 3 – oldest fault)

0x3044 (fault log 0)

Description:	Reads the hexadecimal value of the fault code for the most recent fault for the installed cartridge. If there is no fault, this reads a value of 0x0000 (0-00-0). Convert the hexadecimal value to decimal. Refer to <i>Fault code list</i> on page 34 for the complete list of possible fault codes.
Encoding or scaling:	10-bit effective unsigned binary number from the LSB of a 16-bit binary number
Unit:	N/A
Function (hex):	04 (Read Registers)

0x3045 (fault log 1)

Description: Reads the hexadecimal value of the fault code for the second most-recent fault for the installed cartridge. If there is no fault, this reads a value of 0x0000 (0-00-0).
Convert the hexadecimal value to decimal.
Refer to *Fault code list* on page 34 for the complete list of possible fault codes.

Encoding or scaling: 10-bit effective unsigned binary number from the LSB of a 16-bit binary number

Unit: N/A

Function (hex): 04 (Read Registers)

0x3046 (fault log 2)

Description: Reads the hexadecimal value of the fault code for the third most-recent fault for the installed cartridge. If there is no fault, this reads a value of 0x0000 (0-00-0).
Convert the hexadecimal value to decimal.
Refer to *Fault code list* on page 34 for the complete list of possible fault codes.

Encoding or scaling: 10-bit effective unsigned binary number from the LSB of a 16-bit binary number

Unit: N/A

Function (hex): 04 (Read Registers)

0x3047 (fault log 3)

Description: Reads the hexadecimal value of the fault code for the fourth most-recent fault for the installed cartridge. If there is no fault, this reads a value of 0x0000 (0-00-0).
Convert the hexadecimal value to decimal.
Refer to *Fault code list* on page 34 for the complete list of possible fault codes.

Encoding or scaling: 10-bit effective unsigned binary number from the LSB of a 16-bit binary number

Unit: N/A

Function (hex): 04 (Read Registers)

Example request and response

Request from CNC:

```
:01043044000483<CR><LF>
```

Value	Description
:	Start of message
01	Plasma power supply node address
04	Read Registers
3044	First register address (0x3044)
0004	Quantity of registers to read (0x0004 = 4): <ul style="list-style-type: none"> ▪ 0x3044 (fault log 0) ▪ 0x3045 (fault log 1) ▪ 0x3046 (fault log 2) ▪ 0x3047 (fault log 3)
83	LRC
<CR><LF>	End

Response from plasma power supply:

```
:0104080079007900000000001<CR><LF>
```

Value	Description
:	Start of message
01	Plasma power supply node address (confirmed)
04	Read Registers (confirmed)
08	Quantity of bytes in the Data segment (0x08 = 8)
0079	0x0079 = 0121 = fault code 0-12-1 (output gas pressure is low) (newest fault)
0079	0x0079 = 0121 = fault code 0-12-1 (output gas pressure is low)
0000	0x0000 = 0000 = 0-00-0 (no fault code)
0000	0x0000 = 0000 = 0-00-0 (no fault code) (oldest fault)
01	LRC
<CR><LF>	End

Read the name of the installed cartridge

To read the name of the installed cartridge, the CNC reads the values in the following registers:

- **0x3048** (name, bytes 0 and 1)
- **0x3049** (name, bytes 2 and 3)
- **0x304A** (name, bytes 4 and 5)
- **0x304B** (name, bytes 6 and 7)
- **0x304C** (name, bytes 8 and 9)
- **0x304D** (name, bytes 10 and 11)

0x3048 – 0x304D (cartridge name, bytes 0 – 11)

Description: Reads the hexadecimal values for the 12 bytes of the name of the installed cartridge.

Convert the hexadecimal values to ASCII text.

Refer to *Table 7*.

Encoding or scaling: N/A

Unit: N/A

Function (hex): 04 (Read Registers)

Table 7 – Cartridge names

Hex value	ASCII Text	Cartridge Name
43204D454348000000000000	C MECH	Standard Mechanized Cutting
43204D464E43000000000000	C MFNC	FineCut Mechanized Cutting
4720434E544C000000000000	G CNTL	Maximum Control Gouging*
4720524D564C000000000000	G RMVL	Maximum Removal Gouging
432048414E44000000000000	C HAND	Drag Hand Cutting
432048464E43000000000000	C HFNC	FineCut Hand Cutting
4320464C5553480000000000	C FLUSH	FlushCut Cutting*

*Powermax65/85/105

Example request and response

Request from CNC:

```
:0104304800067D<CR><LF>
```

Value	Description
:	Start of message
01	Plasma power supply node address
04	Read Registers
3048	First register address
0006	Quantity of registers to read (0x0006 = 6): <ul style="list-style-type: none"> ▪ 0x3048 (name, bytes 0 and 1) ▪ 0x3049 (name, bytes 2 and 3) ▪ 0x304A (name, bytes 4 and 5) ▪ 0x304B (name, bytes 6 and 7) ▪ 0x304C (name, bytes 8 and 9) ▪ 0x304D (name, bytes 10 and 11)
7D	LRC
<CR><LF>	End

Response from plasma power supply:

```
:01040C43204D45434800000000000006F<CR><LF>
```

Value	Description
:	Start of message
01	Plasma power supply node address (confirmed)
04	Read Registers (confirmed)
0C	Quantity of bytes in the Data segment (0x0C = 12)
43204D454348000000000000	= C MECH (ASCII) = Standard Mechanized Cutting
6F	LRC
<CR><LF>	End

Read the Start and Motion signal status of the plasma power supply

To read the status of the plasma power supply, the CNC reads the following coils:

- **0x3100** (coil: Start switch signal status)
- **0x3101** (coil: Motion switch signal status)

0x3100 (coil: Start switch signal status)

Description:	Reads the hexadecimal value of the Start switch signal status coil. Convert the hexadecimal value to binary, as follows: <ul style="list-style-type: none">▪ 0x00 = 0 (binary) = OFF (Start input is OFF)▪ 0x01 = 1 (binary) = ON (Start input is ON) When the Start input is OFF, the plasma power supply is idle. When the Start input is ON, there is a pilot arc or the arc has transferred.
Encoding or scaling:	N/A
Unit:	N/A
Function (hex):	01 (Read Coil)

0x3101 (coil: Motion switch signal status)

Description:	Reads the hexadecimal value of the Motion switch signal status coil. Convert the hexadecimal value to binary, as follows: <ul style="list-style-type: none">▪ 0x00 = 0 (binary) = OFF (Motion output is OFF)▪ 0x01 = 1 (binary) = ON (Motion output is ON) When the Motion output is OFF, there is no motion. When the Motion output is ON, there is motion.
Encoding or scaling:	N/A
Unit:	N/A
Function (hex):	01 (Read Coil)

Example request and response

Request from CNC to read 1 coil:

:010131000001CC<CR><LF>

Value	Description
:	Start of message
01	Plasma power supply node address
01	Read Coil
3100	Coil address (0x3100)
0001	Quantity of coils to read (0x0001 = 1): <ul style="list-style-type: none"> ▪ 0x3100 (Start switch signal status)
CC	LRC
<CR><LF>	End

Response from plasma power supply for a read of 1 coil:

:01010100FD<CR><LF>

Value	Description
:	Start of message
01	Plasma power supply node address (confirmed)
01	Read Coil (confirmed)
01	Quantity of bytes in the Data segment (0x01 = 1)
00	0x00 = 0 (binary) = OFF (Start input is OFF)
FD	LRC
<CR><LF>	End

Request from CNC to read both coils at one time:

:010131000002CB<CR><LF>

Value	Description
:	Start of message
01	Plasma power supply node address
01	Read Coil
3100	Coil address (0x3100)
0002	Quantity of coils to read (0x0002 = 2): <ul style="list-style-type: none"> ▪ 0x3100 (Start switch signal status) ▪ 0x3101 (Motion switch signal status)
CB	LRC
<CR><LF>	End

Response from plasma power supply:

:01010103FA<CR><LF>

Value	Description
:	Start of message
01	Plasma power supply node address (confirmed)
01	Read Coil (confirmed)
01	Quantity of bytes in the Data segment (0x01 = 1)
03	0x03 = 11 (binary) = <ul style="list-style-type: none">▪ 1 (binary) = ON (Start input is ON)▪ 1 (binary) = ON (Motion input is ON)
FA	LRC
<CR><LF>	End

Flowchart Examples

This section contains examples of how you can program your CNC using the information in this guide. Examples for Powermax45/65/85/105 SYNC and older plasma power supplies are included. Older Powermax plasma power supplies include Powermax65/85/105/125 and Powermax45 XP.

Example	Page
Figure 1 – Operator selects the plasma power supply type (SYNC / older)	page 62
Figure 2 – CNC automatically selects the plasma power supply type (SYNC / older)	page 63
Figure 3 – CNC requests plasma power supply and torch lead information	page 64
Figure 4 – Exit remote control mode	page 64
Figure 5 – CNC reads and sets permitted cut mode, amperage, and gas pressure	page 65
Figure 6 – CNC requests SYNC plasma power supply and cartridge data	page 66
Figure 7 – CNC starts and stops a gas test	page 67
Figure 8 – Serial communications during SYNC quick restart and cold restart (fault 0-19-9)	page 68
Figure 9 – Continue cutting after SYNC restart, cartridge change, or cartridge fault	page 69
Figure 10 – Stop SYNC cap-off fault 0-50-0	page 70
Figure 11 – Continuously check for SYNC faults / plasma power supply readiness	page 71
Figure 12 – SYNC faults that stop with the next Start signal	page 72
Figure 13 – SYNC cartridge end-of-life faults (0-32-0)*, (0-32-1)	page 73
Figure 14 – SYNC faults that require action to continue to cut	page 74
Figure 15 – Request data from older Powermax plasma power supplies	page 75
Figure 16 – Operator or CNC does gas test to check air supply capacity	page 76
Figure 17 – Behavior when SYNC tries to read the cartridge after cartridge installation	page 77
Figure 18 – (Mech/mini) Cartridge cannot send data to the power supply (fault 0-14-0)	page 78
Figure 19 – (Hand torch) Cartridge cannot send data to the power supply (fault 0-14-0)	page 79

Figure 1 – Operator selects the plasma power supply type (SYNC / older)

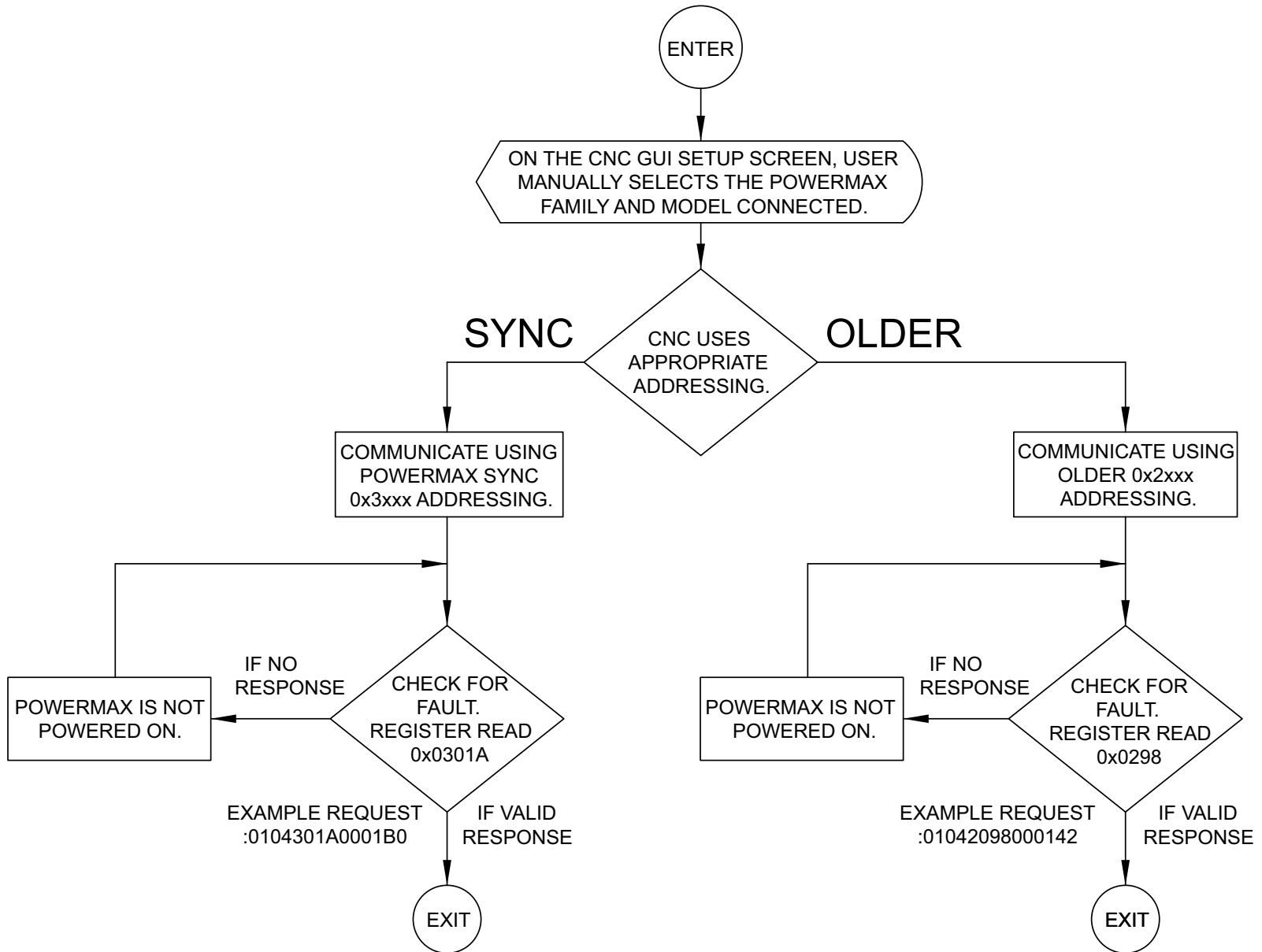

Figure 2 – CNC automatically selects the plasma power supply type (SYNC / older)

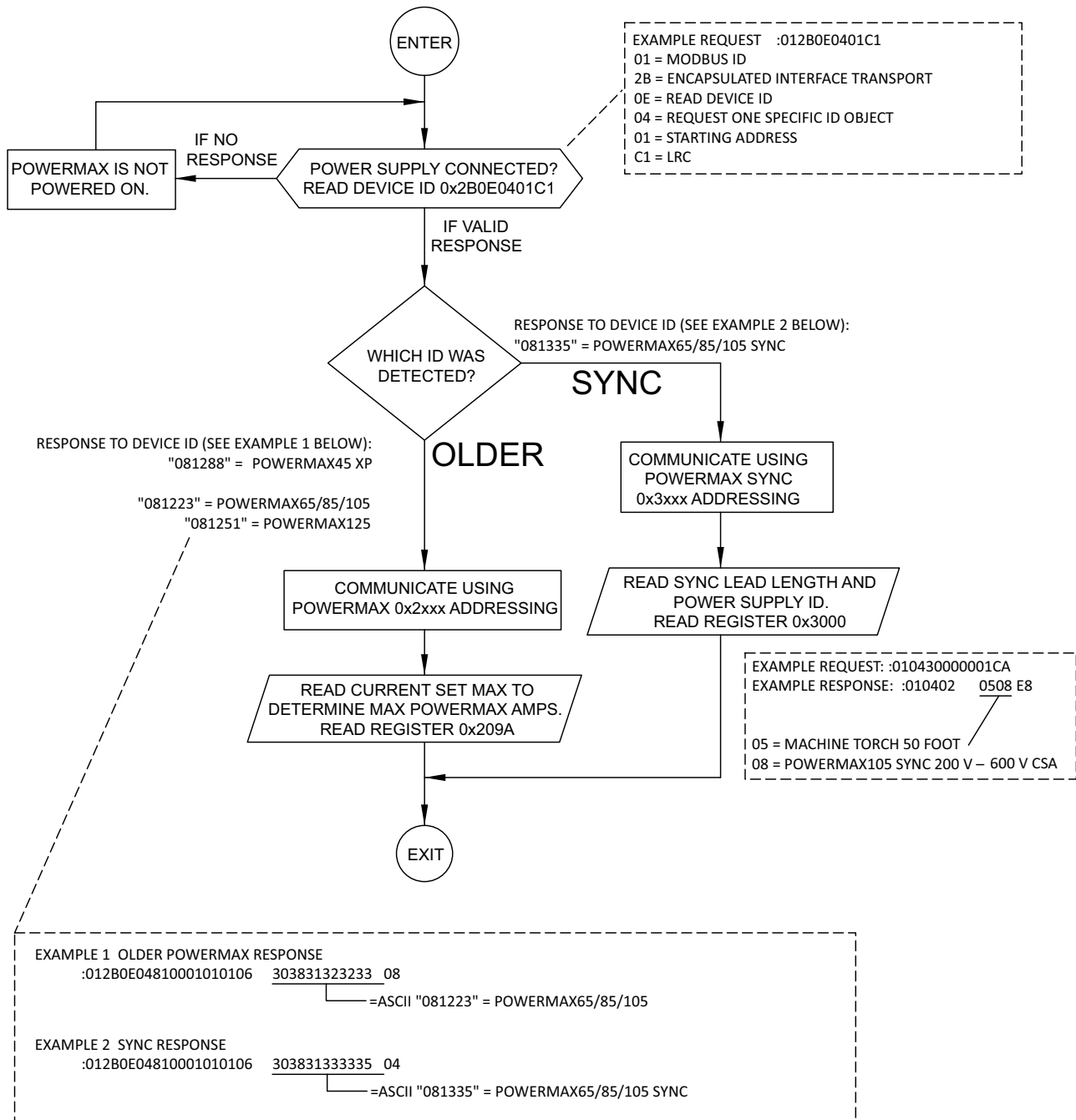

Figure 3 – CNC requests plasma power supply and torch lead information

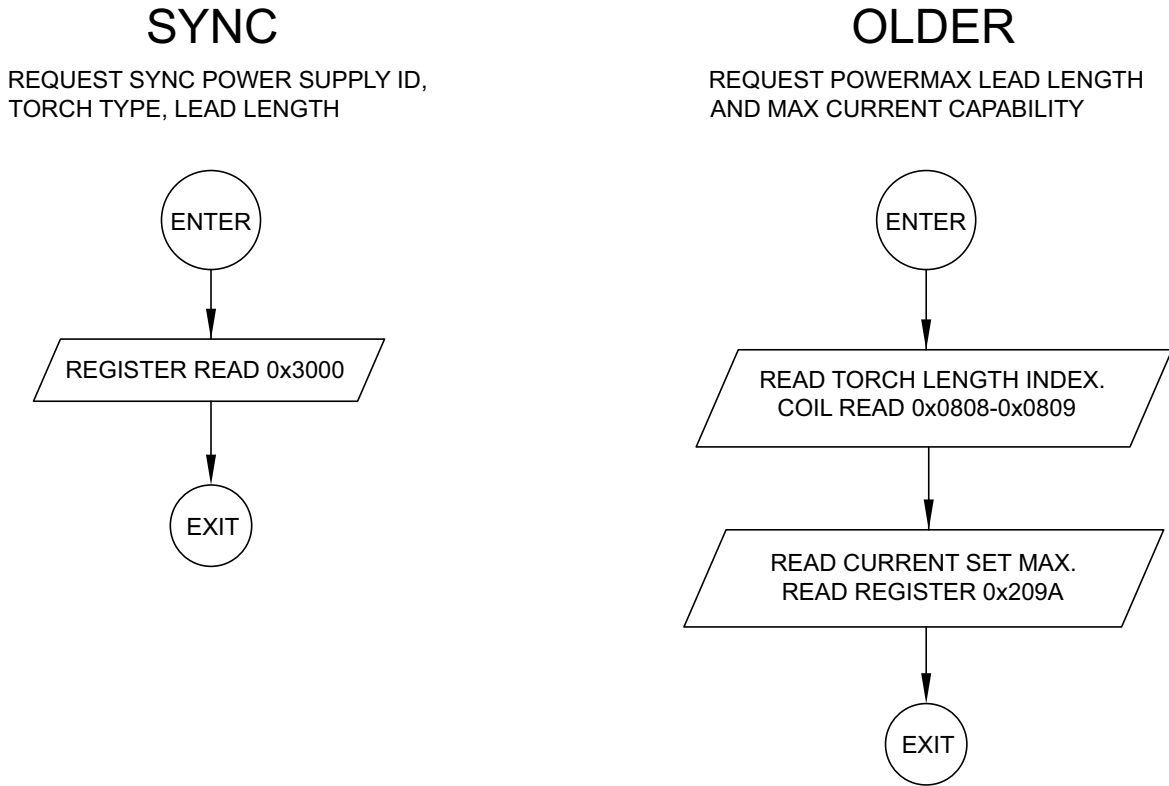

Figure 4 – Exit remote control mode

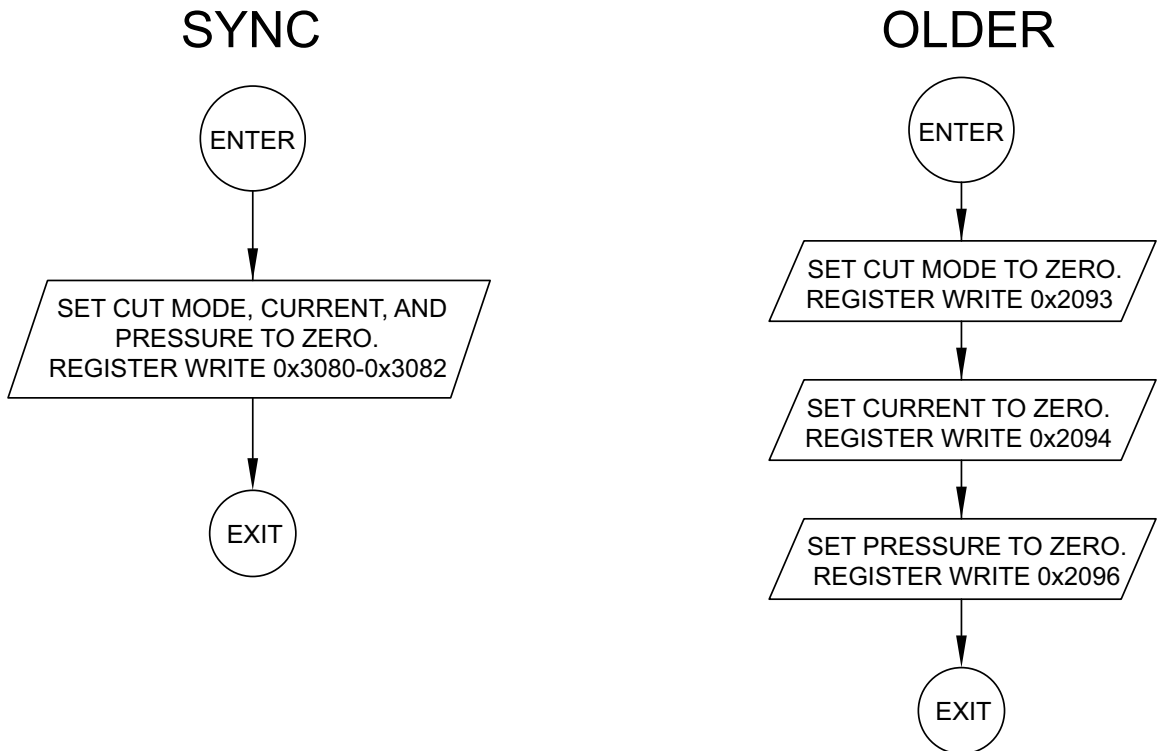

Figure 5 – CNC reads and sets permitted cut mode, amperage, and gas pressure

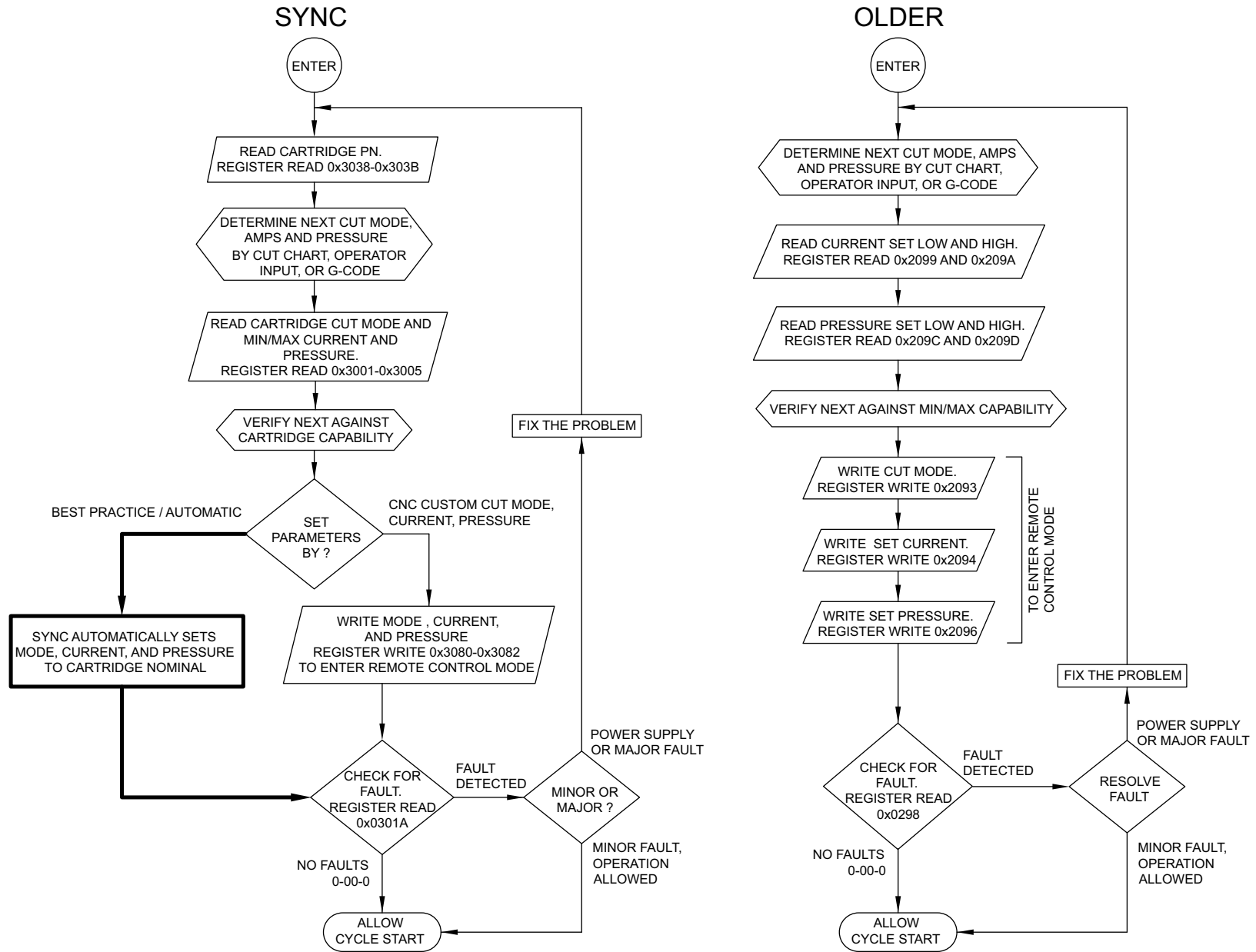

Figure 6 – CNC requests SYNC plasma power supply and cartridge data

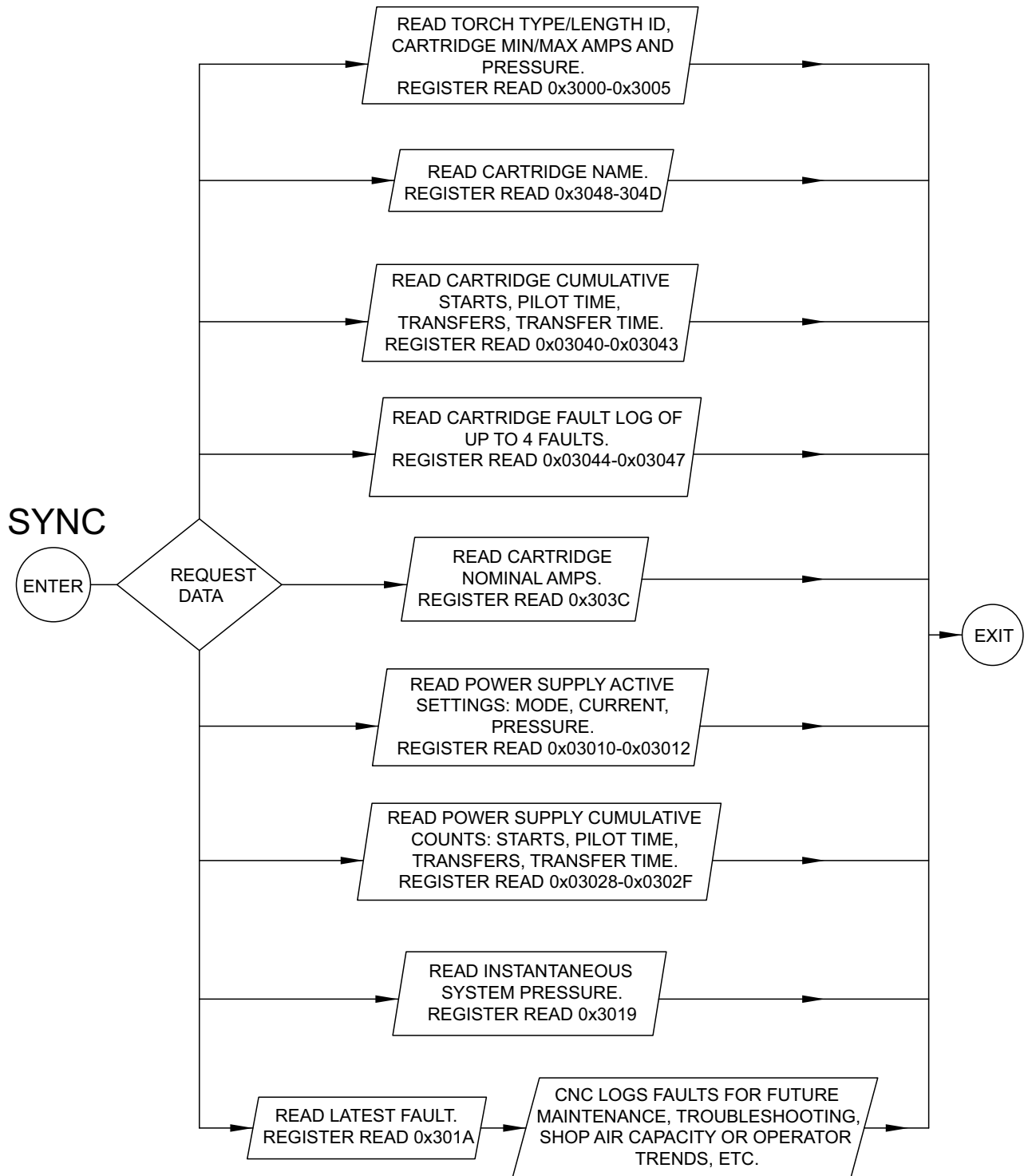

Figure 7 – CNC starts and stops a gas test

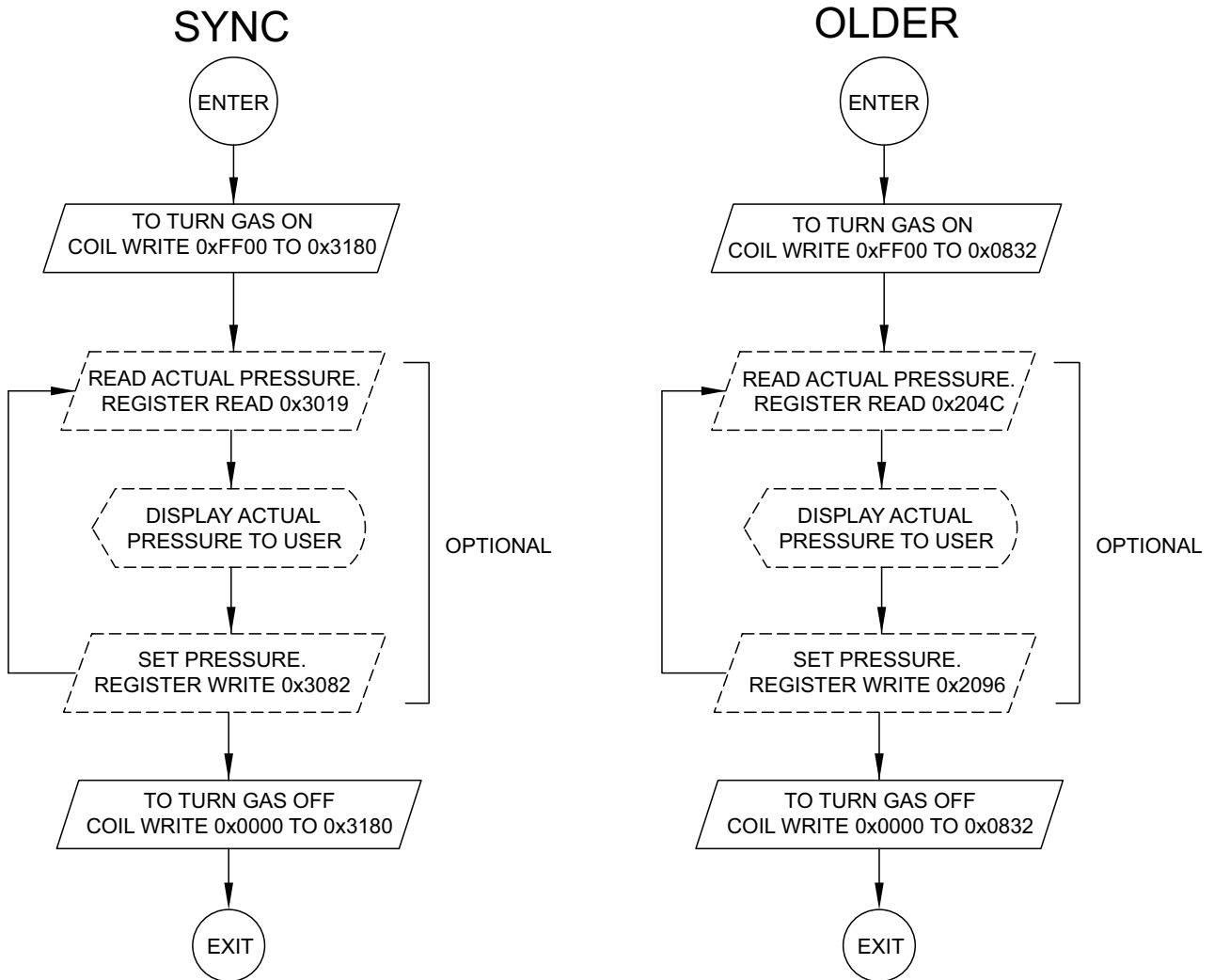

Figure 8 – Serial communications during SYNC quick restart and cold restart (fault 0-19-9)

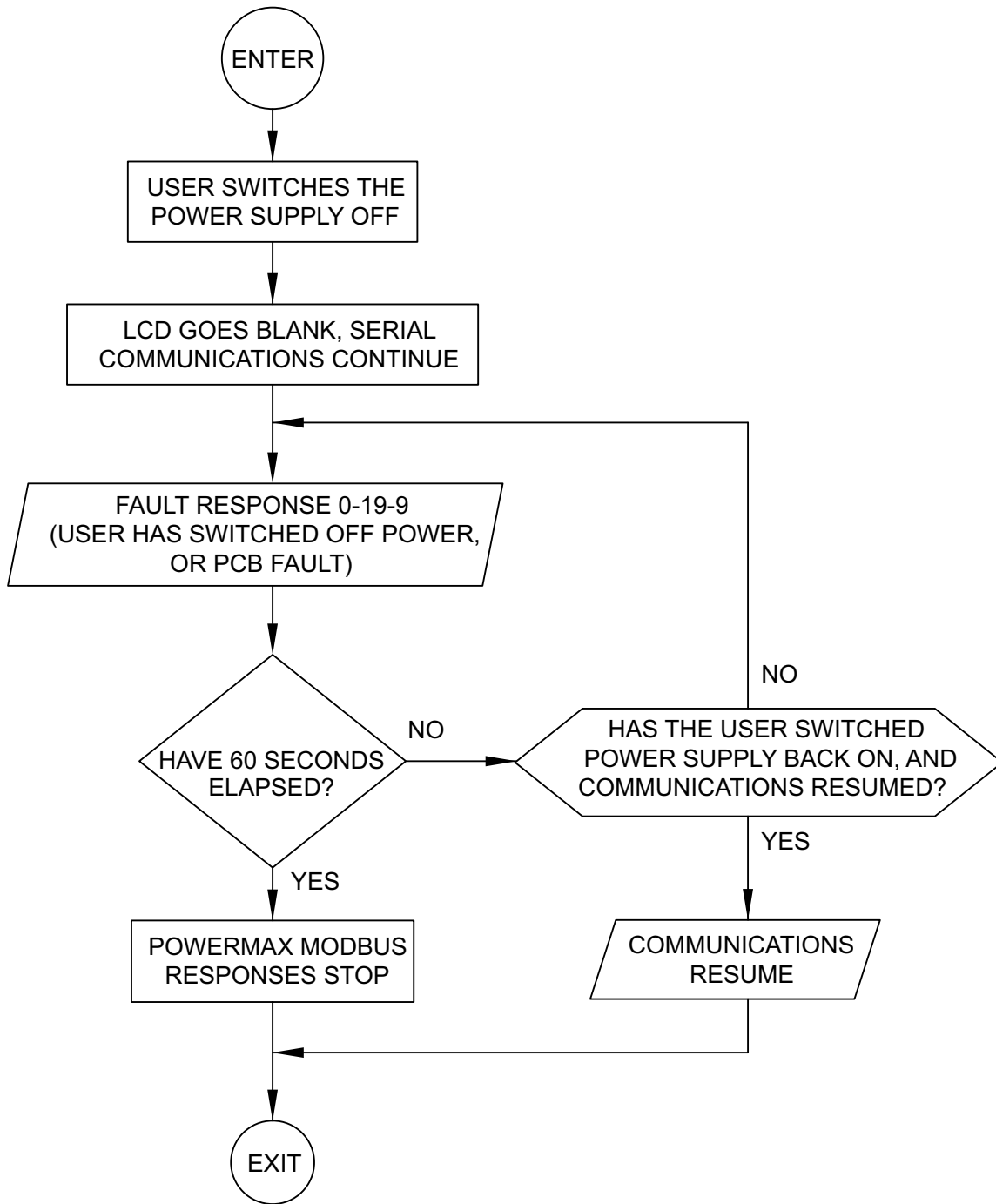

Figure 9 – Continue cutting after SYNC restart, cartridge change, or cartridge fault

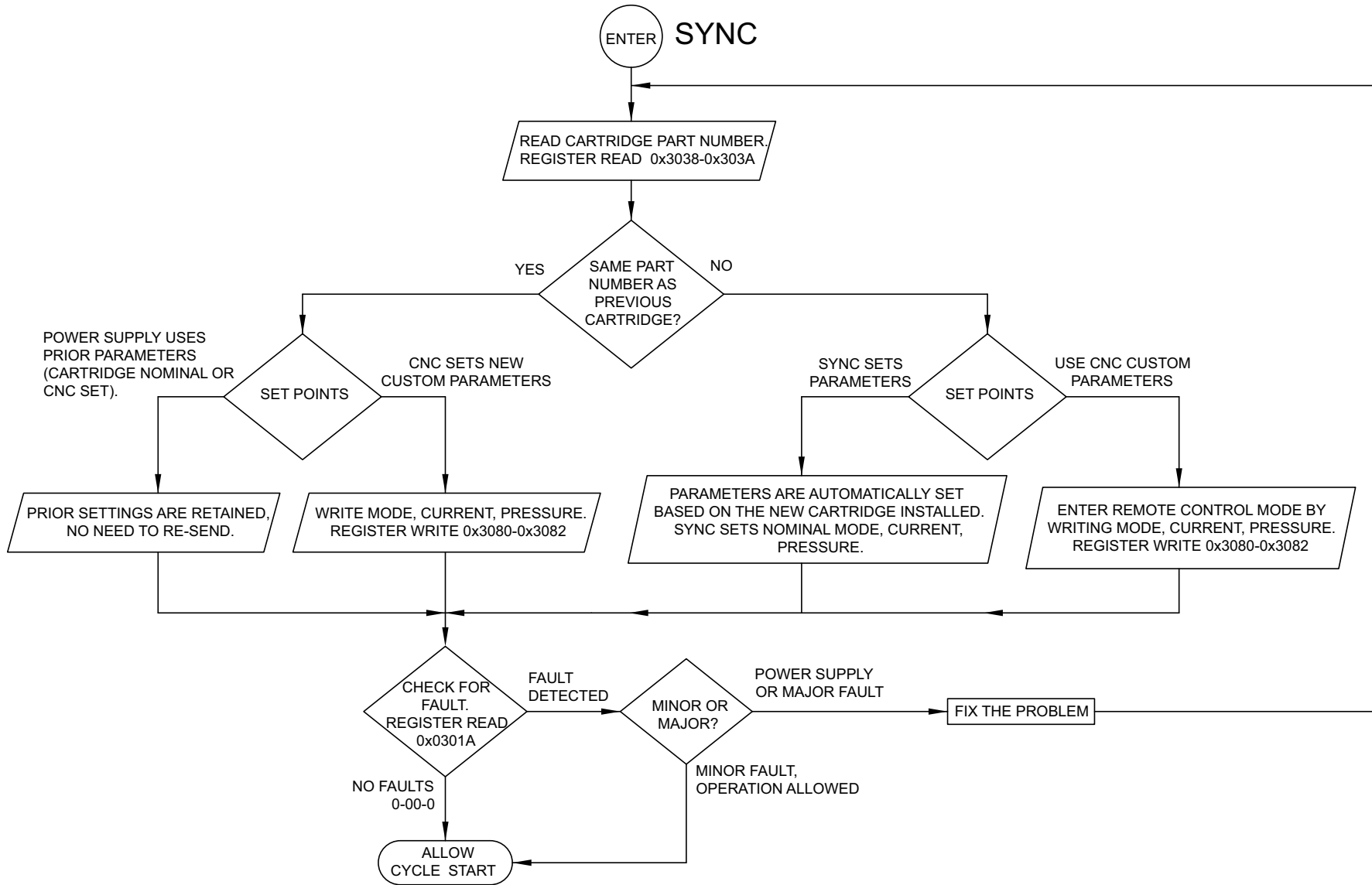
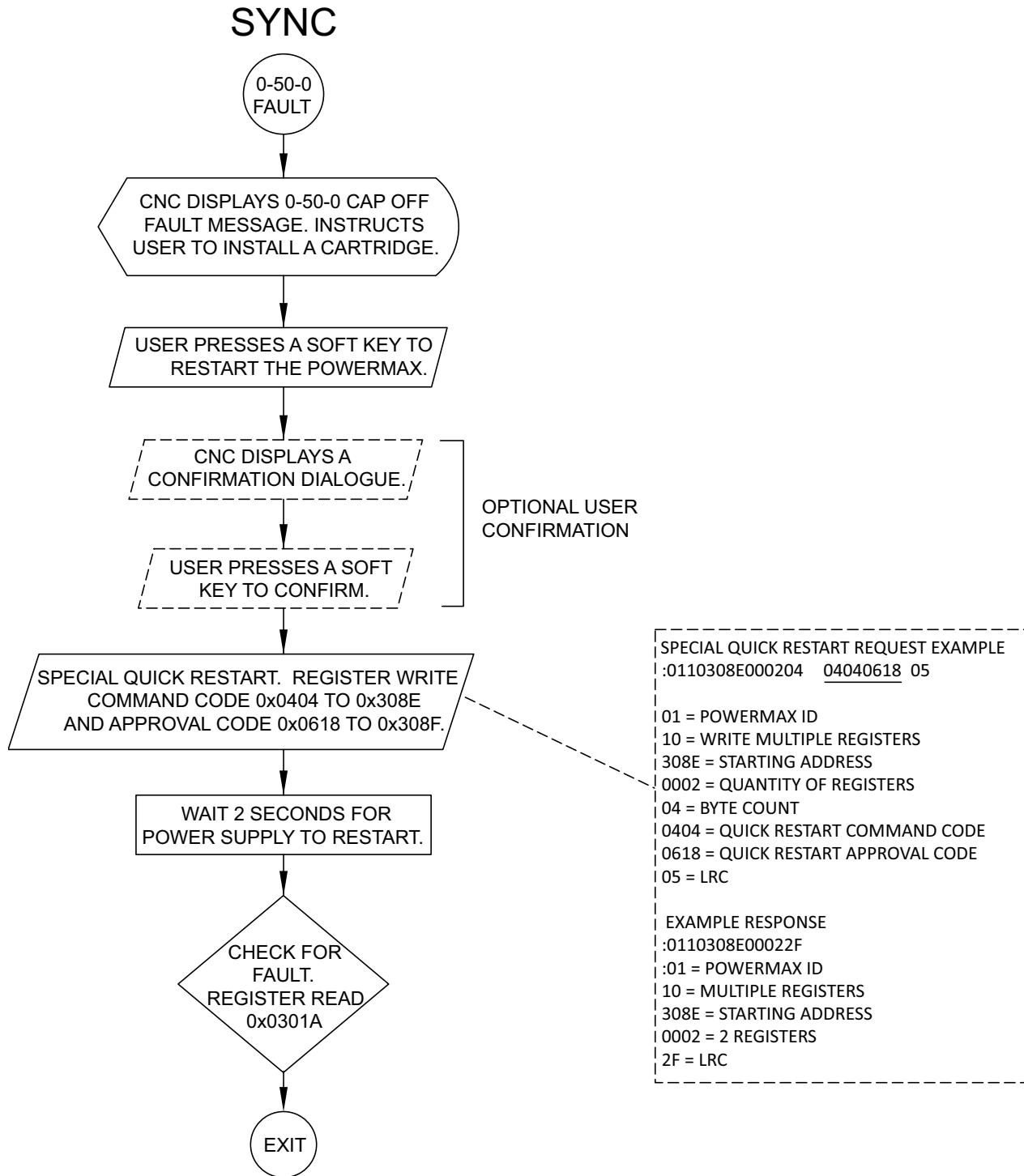

Figure 10 – Stop SYNC cap-off fault 0-50-0



NOTES:

- 1: THE MINI MACHINE TORCH DOES NOT HAVE A LOCK/UNLOCK SWITCH. REMOVING THE CARTRIDGE WITHOUT POWERING OFF THE POWER SUPPLY WILL CAUSE A 0-50-0 FAULT, WHICH PREVENTS A PLASMA START.
2. ONCE A CARTRIDGE IS INSTALLED, 0-50-0 CAN BE STOPPED FROM THE CNC USING THE ABOVE QUICK RESTART COMMAND, OR MANUALLY BY CYCLING THE POWER SUPPLY ON/OFF SWITCH.
3. MAKE SURE THAT THE TORCH IS CONNECTED TO THE PLASMA POWER SUPPLY.

Figure 11 – Continuously check for SYNC faults / plasma power supply readiness

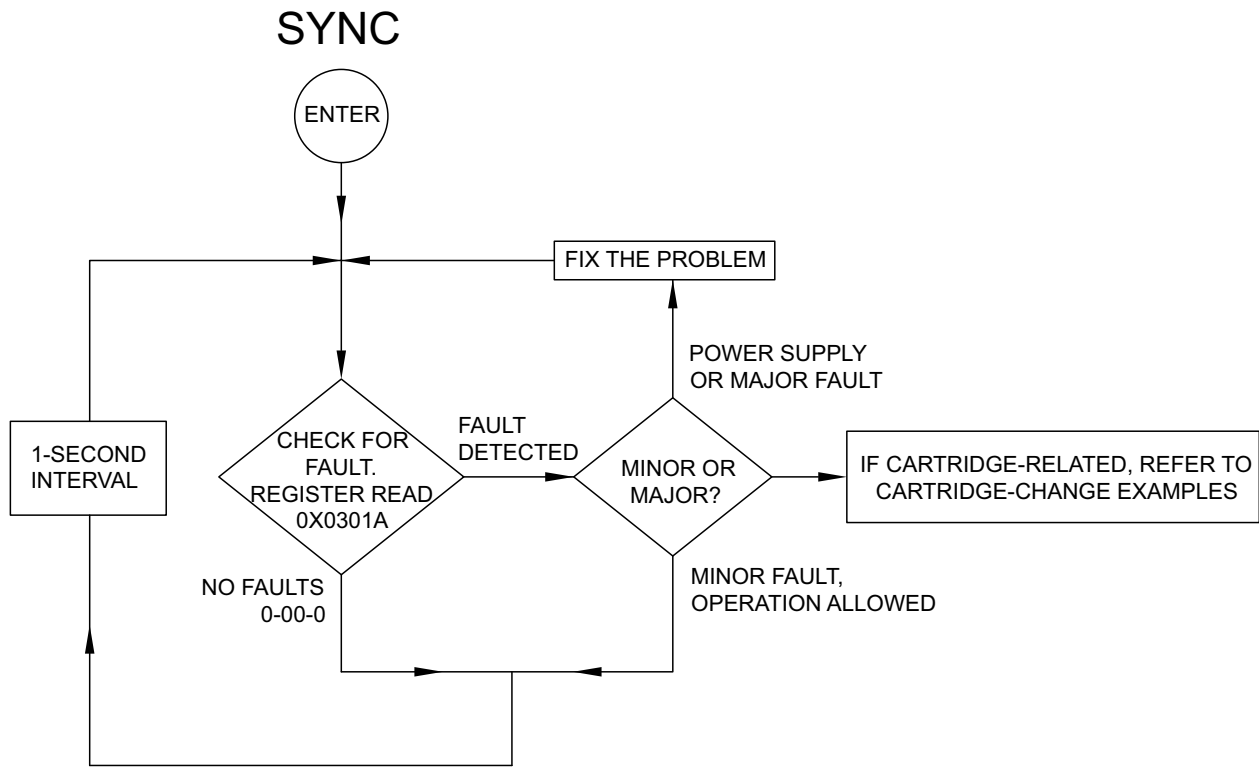

Figure 12 – SYNC faults that stop with the next Start signal

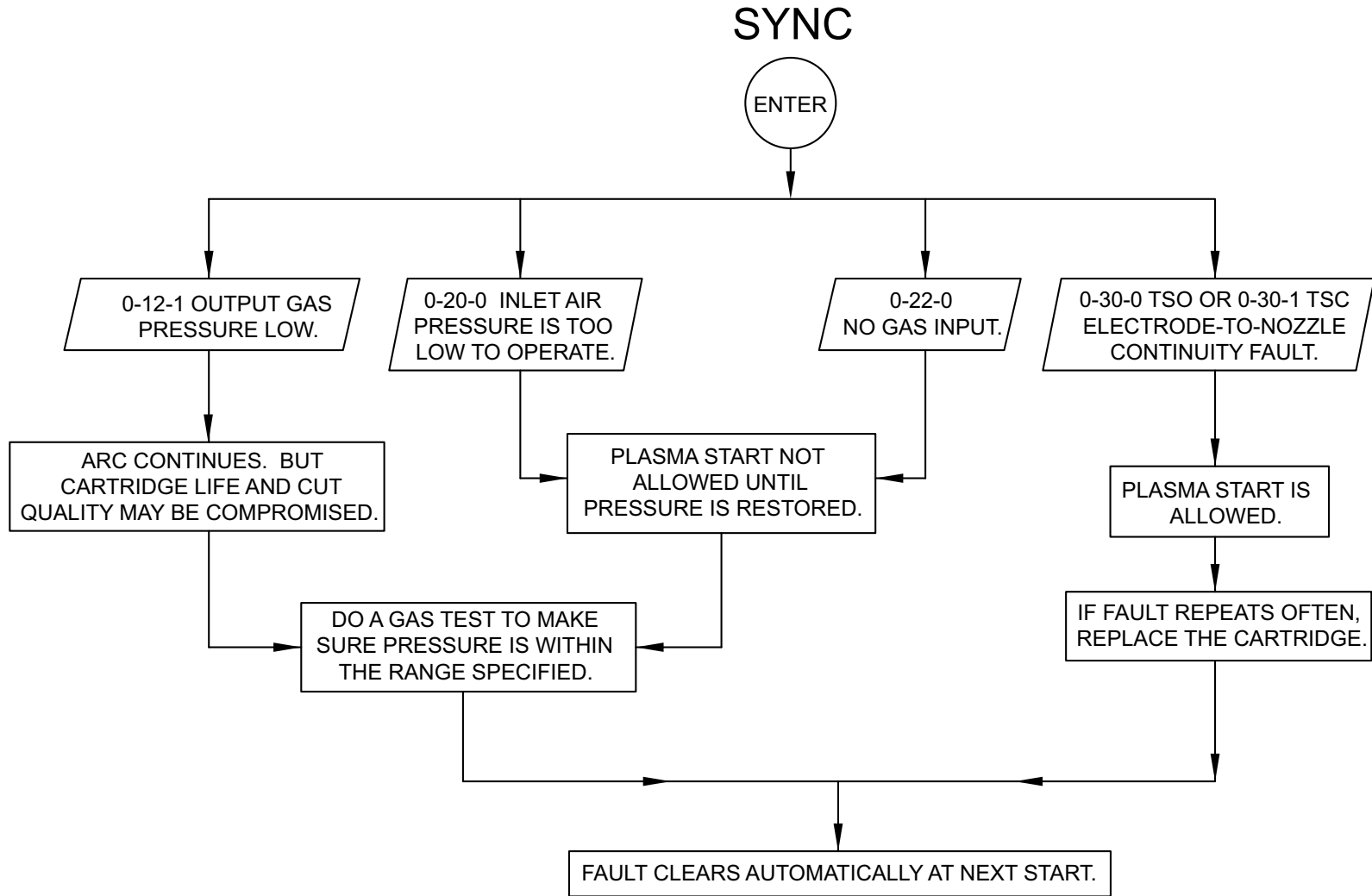
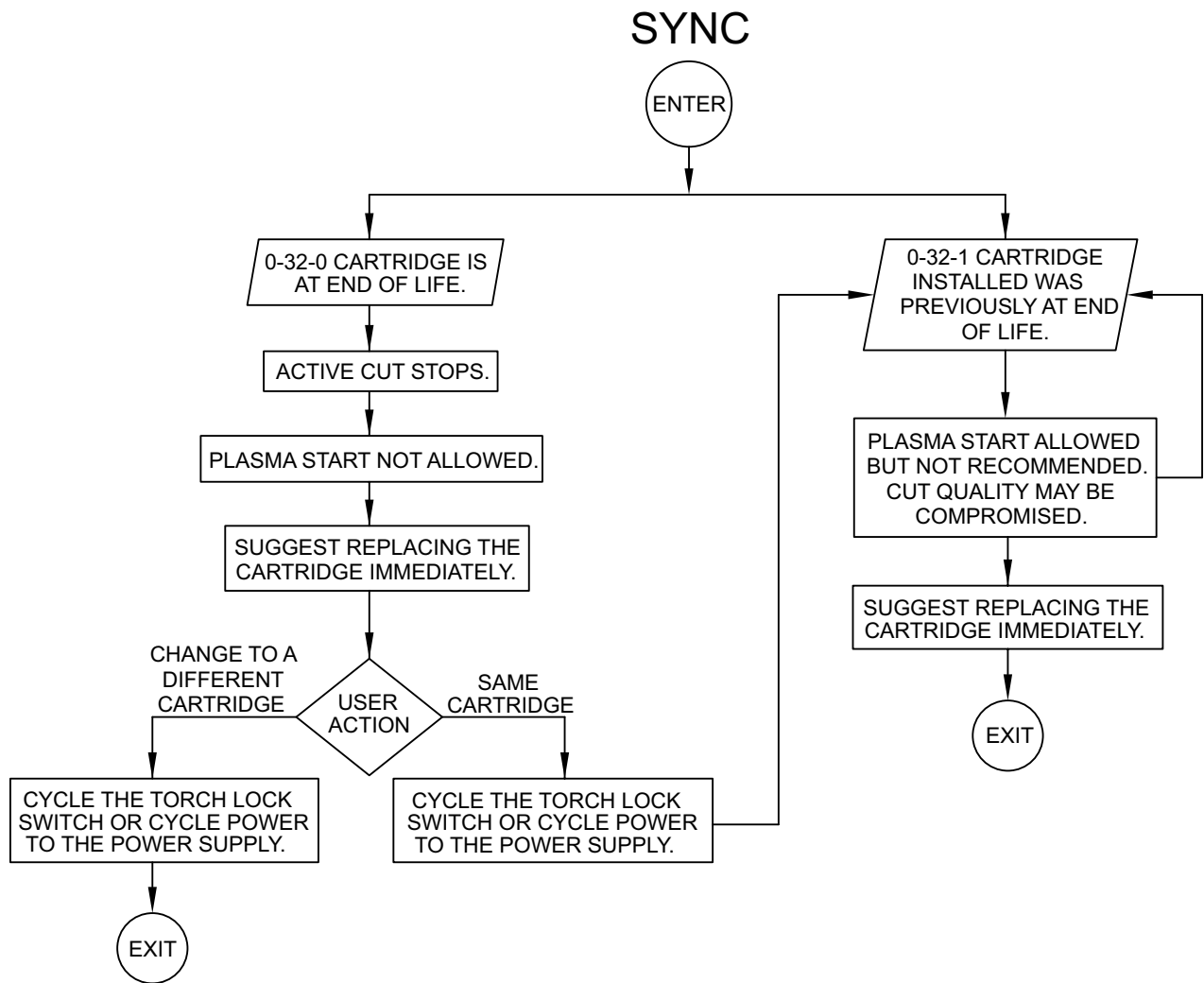

Figure 13 – SYNC cartridge end-of-life faults (0-32-0)*, (0-32-1)



*Powermax65/85/105 SYNC only.

Figure 14 – SYNC faults that require action to continue to cut

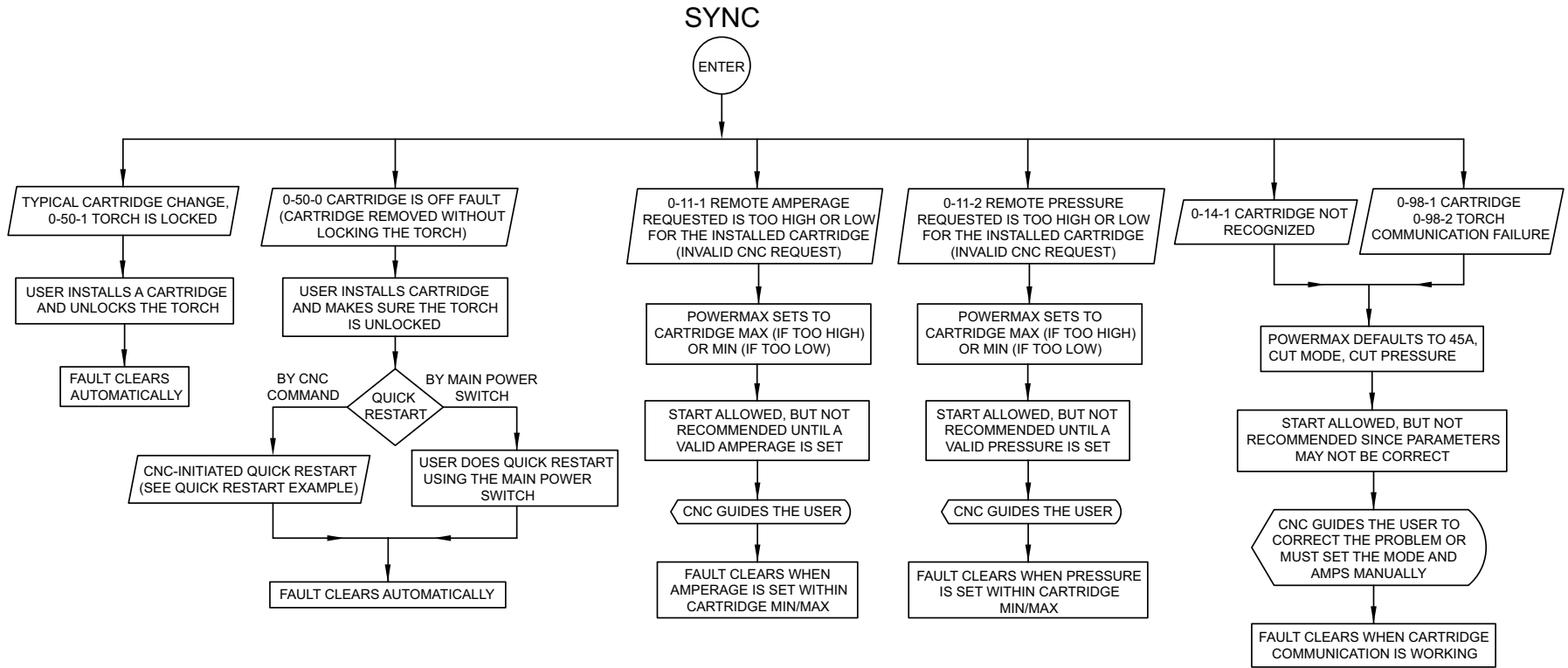

Figure 15 – Request data from older Powermax plasma power supplies

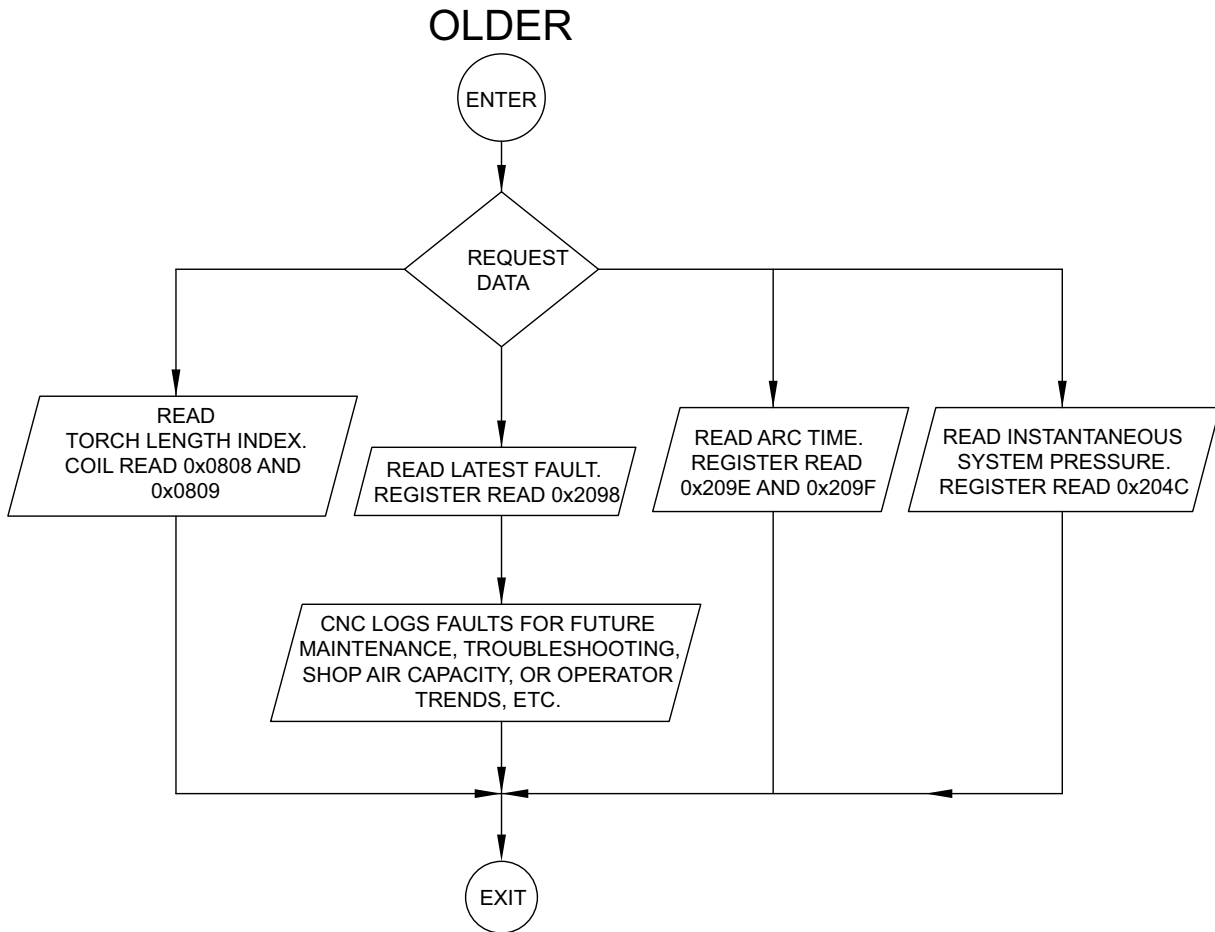
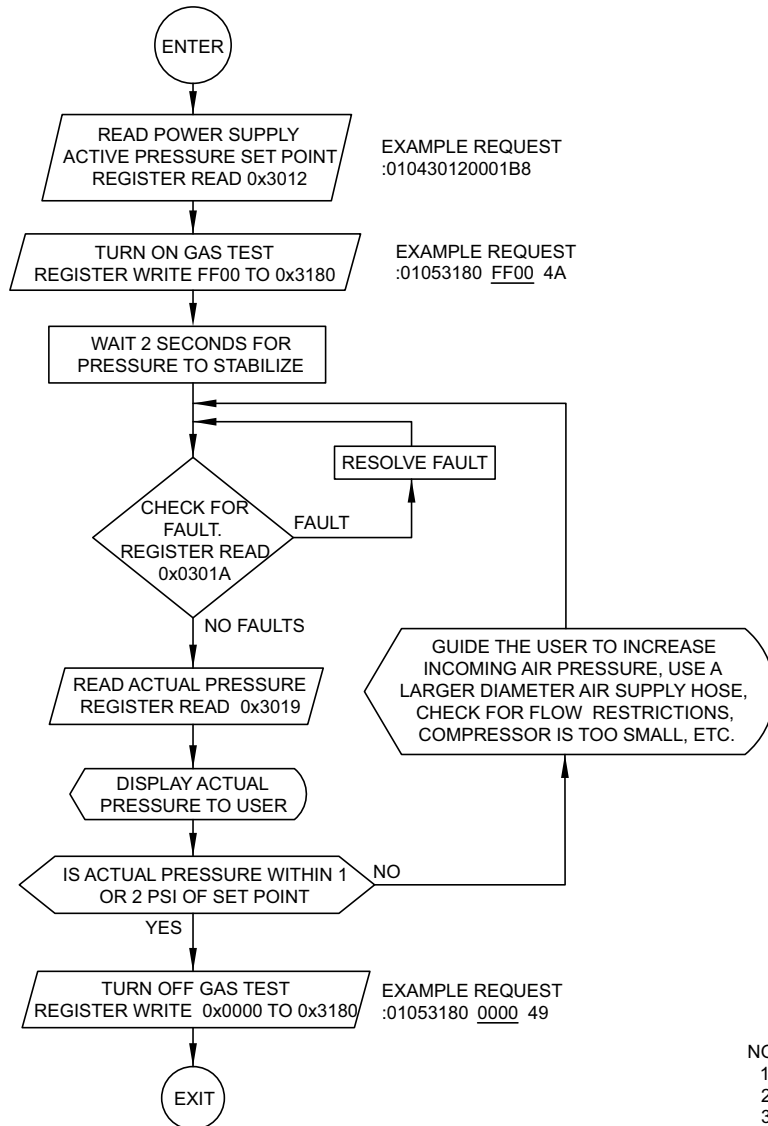
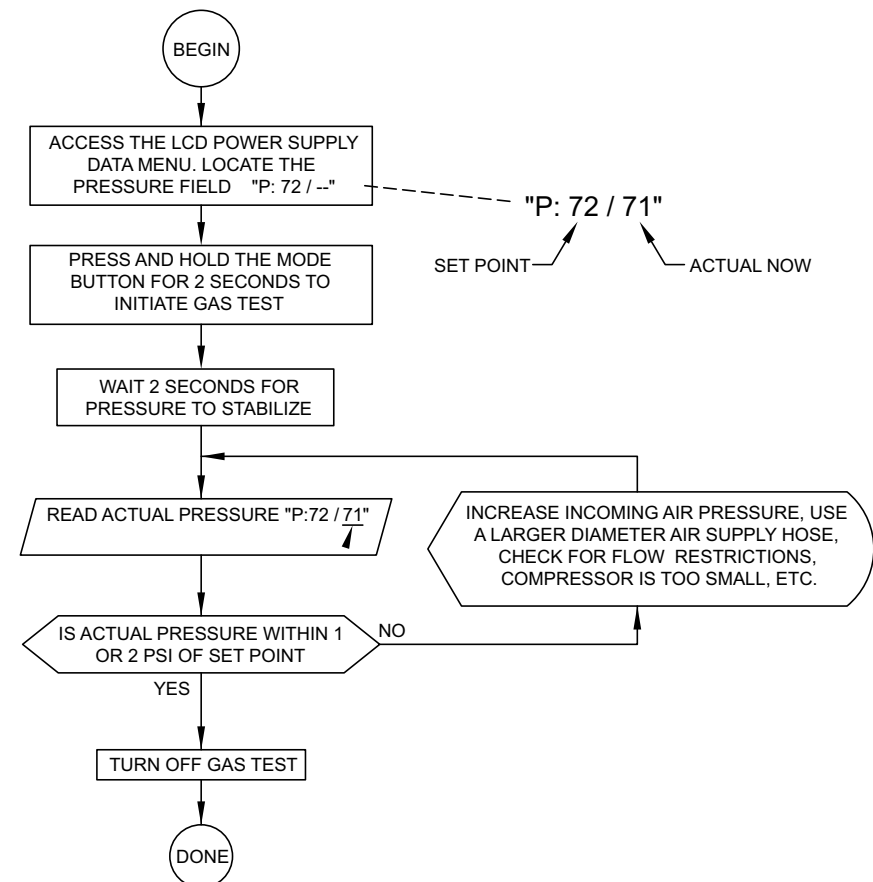

Figure 16 – Operator or CNC does gas test to check air supply capacity

SYNC (CNC AUTOMATES GAS TEST)



SYNC OR OLDER (OPERATOR DOES GAS TEST)



NOTES:

1. TEST WITH THE LARGEST AMPERAGE CARTRIDGE USED AT THE SITE.
2. TEST AT VARIOUS TIMES OF THE DAY WHEN OTHER EQUIPMENT IS TAXING THE COMPRESSOR.
3. TEST IMMEDIATELY AFTER A LONG PERIOD OF CUTTING TO ENSURE THE COMPRESSOR IS KEEPING UP.

Figure 17 – Behavior when SYNC tries to read the cartridge after cartridge installation

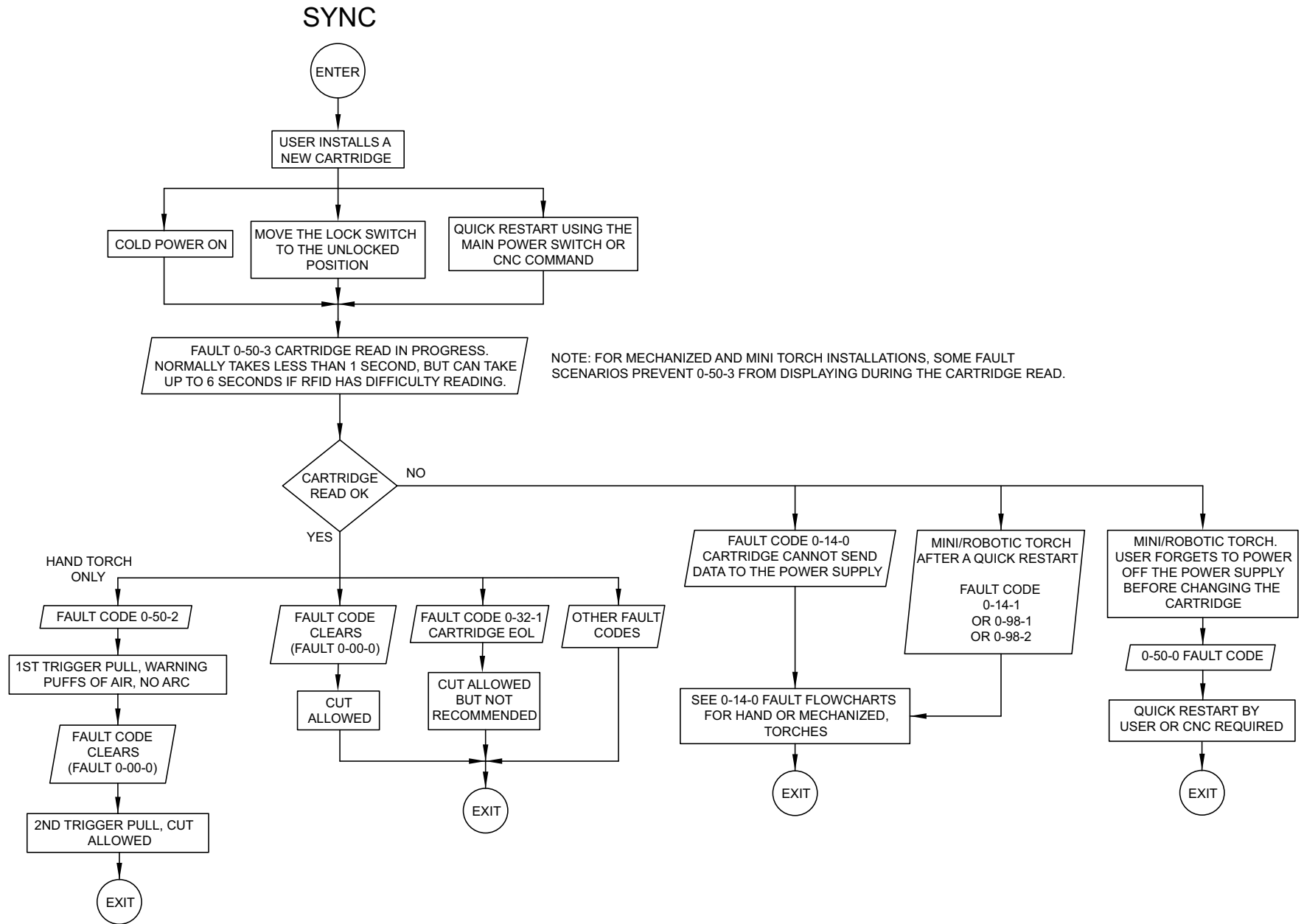

Figure 18 – (Mech/mini) Cartridge cannot send data to the power supply (fault 0-14-0)

SYNC - MECH/MINI (CLEAR THE FAULT OR SET PARAMETERS MANUALLY)

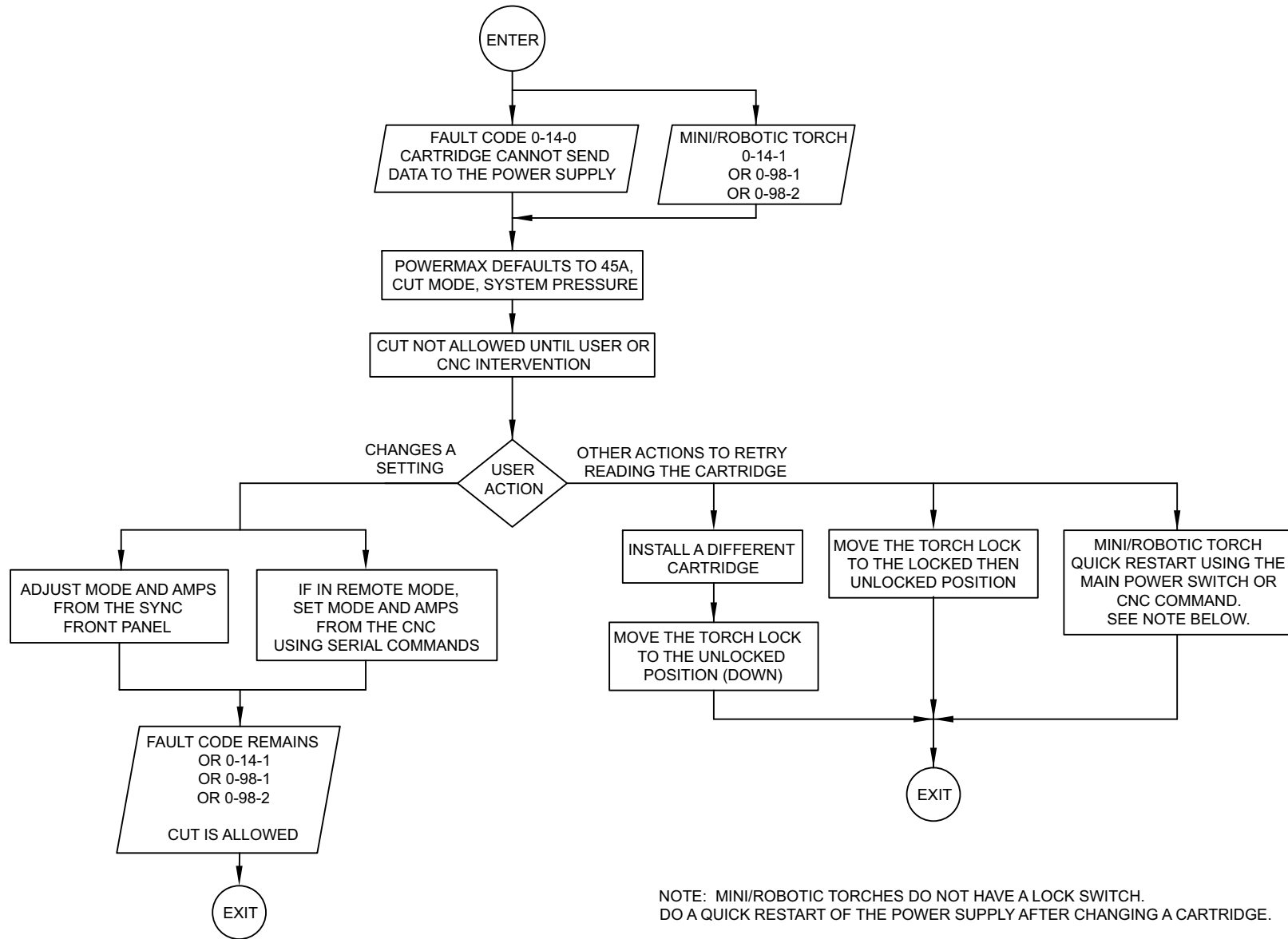

Figure 19 – (Hand torch) Cartridge cannot send data to the power supply (fault 0-14-0)

SYNC - HAND TORCH (CLEAR THE FAULT OR SET PARAMETERS MANUALLY)

